

AOC

GAMING



USER MANUAL

CQ27G4Z2

AOC GAMING MONITOR

Safety	1
National Conventions.....	1
Power	2
Installation	3
Cleaning.....	4
Other	5
Setup.....	6
Contents in Box.....	6
Set-up Stand & Base.....	7
Adjusting Viewing Angle.....	8
Connecting the Monitor	9
Wall Mounting	10
Adaptive-Sync function.....	11
HDR.....	12
Adjusting.....	13
Hotkeys.....	13
OSD Setting	14
Game Setting.....	15
Picture	17
Settings.....	20
Audio	21
OSD Setup.....	22
Information.....	23
LED Indicator.....	24
Troubleshoot.....	25
Specification.....	26
General Specification.....	26
AOC Monitors Panel Pixel Defect Policy	28
Preset Display Modes.....	30
Pin Assignments.....	31
Plug and Play.....	32

Safety

National Conventions

The following subsections describe national conventions used in this document.

Notes, Cautions, and Warnings

Throughout this guide, blocks of text may be accompanied by an icon and printed in bold type or in italic type. These blocks are notes, cautions, and warnings, and they are used as follows:



NOTE: A NOTE indicates important information that helps you make better use of your computer system.





CAUTION: A CAUTION indicates either potential damage to hardware or loss of data and tells you how to avoid the problem.



WARNING: A WARNING indicates the potential for bodily harm and tells you how to avoid the problem. Some warnings may appear in alternate formats and may be unaccompanied by an icon. In such cases, the specific presentation of the warning is mandated by regulatory authority.

Power

 The monitor should be operated only from the type of power source indicated on the label. If you are not sure of the type of power supplied to your home, consult your dealer or local power company.

 The monitor is equipped with a three-pronged grounded plug, a plug with a third (grounding) pin. This plug will fit only into a grounded power outlet as a safety feature. If your outlet does not accommodate the three-wire plug, have an electrician install the correct outlet, or use an adapter to ground the appliance safely. Do not defeat the safety purpose of the grounded plug.

 Unplug the unit during a lightning storm or when it will not be used for long periods of time. This will protect the monitor from damage due to power surges.

 Do not overload power strips and extension cords. Overloading can result in fire or electric shock.

 To ensure satisfactory operation, use the monitor only with UL listed computers which have appropriate configured receptacles marked between 100-240V AC, Min. 5A.

 The wall socket shall be installed near the equipment and shall be easily accessible.

Installation

! Do not place the monitor on an unstable cart, stand, tripod, bracket, or table. If the monitor falls, it can injure a person and cause serious damage to this product. Use only a cart, stand, tripod, bracket, or table recommended by the manufacturer or sold with this product. Follow the manufacturer's instructions when installing the product and use mounting accessories recommended by the manufacturer. A product and cart combination should be moved with care.

! Never push any object into the slot on the monitor cabinet. It could damage circuit parts causing a fire or electric shock. Never spill liquids on the monitor.

! Do not place the front of the product on the floor.

! If you mount the monitor on a wall or shelf, use a mounting kit approved by the manufacturer and follow the kit instructions.

! Leave some space around the monitor as shown below. Otherwise, air-circulation may be inadequate hence overheating may cause a fire or damage to the monitor.

! To avoid potential damage, for example the panel peeling from the bezel, ensure that the monitor does not tilt downward by more than -5 degrees. If the -5 degree downward tilt angle maximum is exceeded, the monitor damage will not be covered under warranty.

See below the recommended ventilation areas around the monitor when the monitor is installed on the wall or on the stand:

Installed with stand



Cleaning

⚠ Clean the cabinet regularly with a water-dampened, soft cloth.

⚠ When cleaning use a soft cotton or microfiber cloth. The cloth should be damp and almost dry, do not allow liquid into the case.



⚠ Please disconnect the power cord before cleaning the product.

Other

 If the product is emitting a strange smell, sound or smoke, disconnect the power plug IMMEDIATELY and contact a Service Center.

 Make sure that the ventilating openings are not blocked by a table or curtain.

 Do not engage the LCD monitor in severe vibration or high impact conditions during operation.

 Do not knock or drop the monitor during operation or transportation.

 The power cords shall be safety approved. For Germany, it shall be H03VV-F, 3G, 0.75 mm², or better. For other countries, the suitable types shall be used accordingly.

 Excessive sound pressure from earphones and headphones can cause hearing loss. Adjustment of the equalizer to maximum increases the earphones and headphones output voltage and therefore the sound pressure level.

Setup

Contents in Box

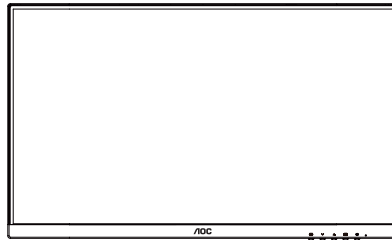

Monitor

*



Quick Start Guide

*



Warranty Card



Stand

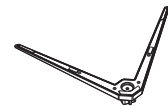

Base



Power Cable

*



HDMI Cable

*



DisplayPort Cable

* Not all signal cables will be provided for all countries and regions. Please check with the local dealer or AOC branch office for confirmation.

Set-up Stand & Base

Please setup or remove the base following the steps as below.

Setup:

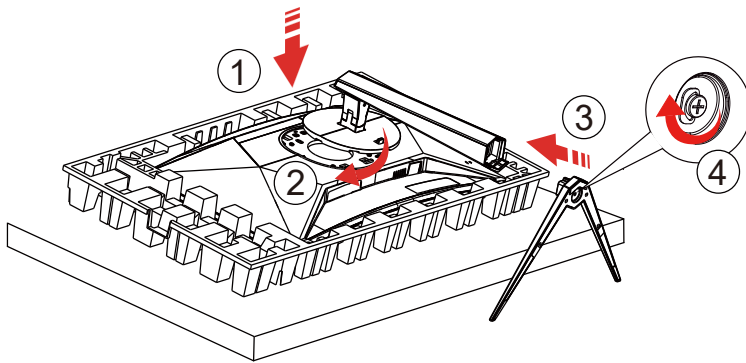

Remove:

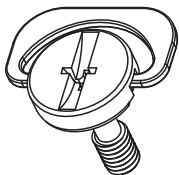
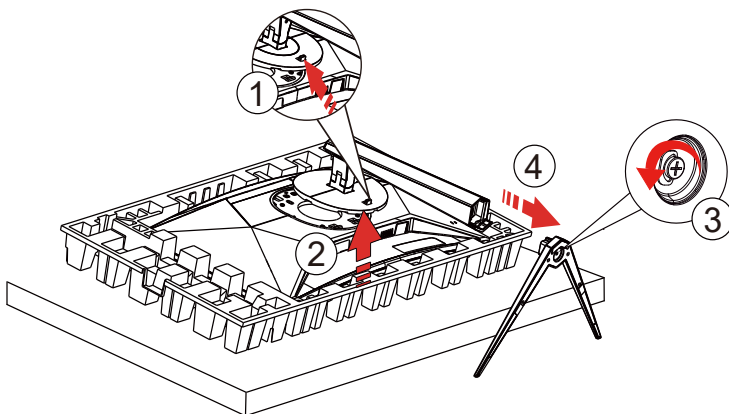

Specification for base screw :
M6 x 23mm (effective thread 5.5mm)

 **NOTE:** Display design may differ from those illustrated.

Adjusting Viewing Angle

To achieve the best viewing experience, it is recommended that the user can make sure they are able to look at their whole face on the screen, then adjust the monitor's angle based on personal preference.

Hold the stand so you will not topple the monitor when you change the monitor's angle.

You are able to adjust the monitor as below:

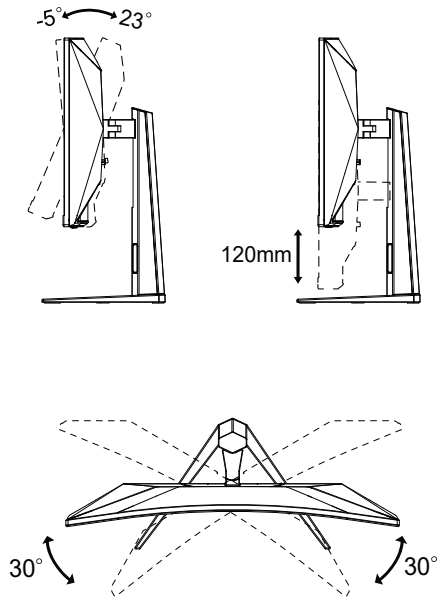

 **NOTE:**

Do not touch the LCD screen when you change the angle. Touching the LCD screen may cause damage.

 **Warning**

- To avoid potential screen damage, such as panel peeling, ensure that the monitor does not tilt downward by more than -5 degrees.
- Do not press the screen while adjusting the angle of the monitor. Grasp only the bezel.

Connecting the Monitor

Cable Connections In Back of Monitor and Computer:

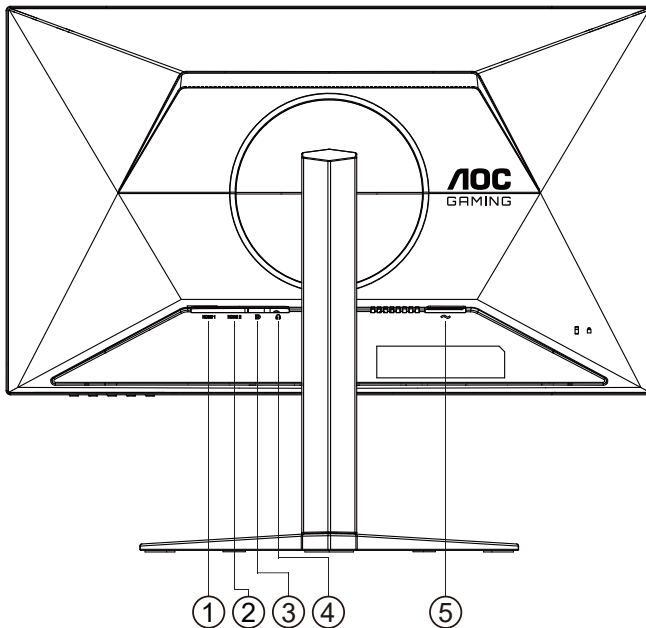

1. HDMI1
2. HDMI2
3. DisplayPort
4. Earphone
5. Power

Connect to PC

1. Connect the power cord to the back of the display firmly.
2. Turn off your computer and unplug its power cable.
3. Connect the display signal cable to the video connector on the back of your computer.
4. Plug the power cord of your computer and your display into a nearby outlet.
5. Turn on your computer and display.

If your monitor displays an image, installation is complete. If it does not display an image, please refer to Troubleshoot.

To protect equipment, always turn off the PC and LCD monitor before connecting.

Wall Mounting

Preparing to Install An Optional Wall Mounting Arm.

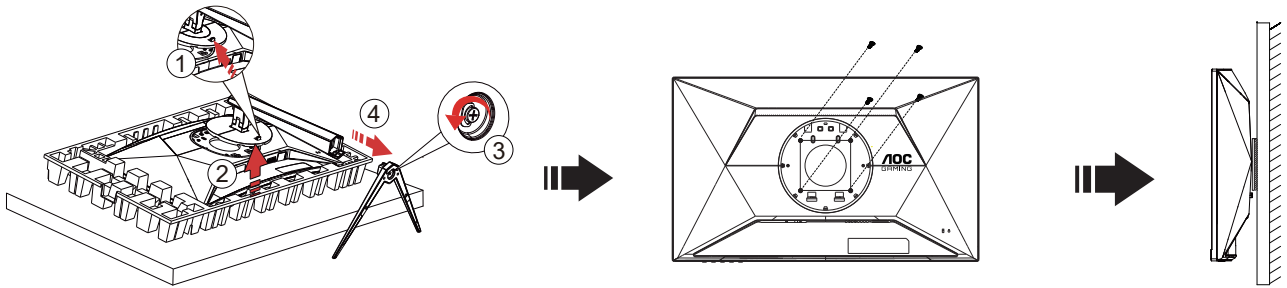

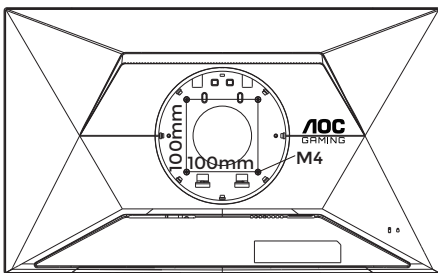

This monitor can be attached to a wall mounting arm you purchase separately. Disconnect power before this procedure. Follow these steps:

1. Remove the base.
2. Follow the manufacturer's instructions to assemble the wall mounting arm.
3. Place the wall mounting arm onto the back of the monitor. Line up the holes of the arm with the holes in the back of the monitor.
4. Insert the 4 screws into the holes and tighten.
5. Reconnect the cables. Refer to the user's manual that came with the optional wall mounting arm for instructions on attaching it to the wall.

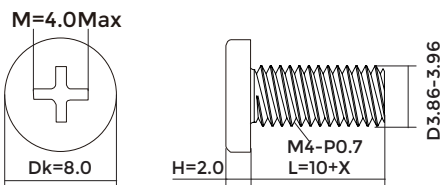

Specification of wall hanger screws: M4*(10+X)mm (X=Thickness of Wall mount bracket)



 **Note:** VESA mounting screw holes are not available for all models, please check with the dealer or official department of AOC. Always contact manufacturer for wall-mount installation.

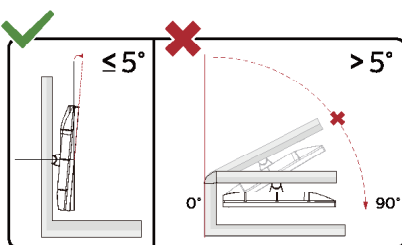

* Display design may differ from those illustrated.

WARNING:

1. To avoid potential screen damage, such as panel peeling, ensure that the monitor does not tilt downward by more than -5 degrees.
2. Do not press the screen while adjusting the angle of the monitor. Grasp only the bezel.

Adaptive-Sync function

1. Adaptive-Sync function works with DisplayPort/HDMI
2. Compatible Graphics Card: Recommended list is as below, also could be checked by visiting www.AMD.com

Graphics Cards

- Radeon™ RX Vega series
- Radeon™ RX 500 series
- Radeon™ RX 400 series
- Radeon™ R9/R7 300 series (R9 370/X, R7 370/X, R7 265 except)
- Radeon™ Pro Duo (2016)
- Radeon™ R9 Nano series
- Radeon™ R9 Fury series
- Radeon™ R9/R7 200 series (R9 270/X, R9 280/X except)

Processors

- AMD Ryzen™ 7 2700U
- AMD Ryzen™ 5 2500U
- AMD Ryzen™ 5 2400G
- AMD Ryzen™ 3 2300U
- AMD Ryzen™ 3 2200G
- AMD PRO A12-9800
- AMD PRO A12-9800E
- AMD PRO A10-9700
- AMD PRO A10-9700E
- AMD PRO A8-9600
- AMD PRO A6-9500
- AMD PRO A6-9500E
- AMD PRO A12-8870
- AMD PRO A12-8870E
- AMD PRO A10-8770
- AMD PRO A10-8770E
- AMD PRO A10-8750B
- AMD PRO A8-8650B
- AMD PRO A6-8570
- AMD PRO A6-8570E
- AMD PRO A4-8350B
- AMD A10-7890K
- AMD A10-7870K
- AMD A10-7850K
- AMD A10-7800
- AMD A10-7700K
- AMD A8-7670K
- AMD A8-7650K
- AMD A8-7600
- AMD A6-7400K

HDR

It is compatible with input signals in HDR10 format.

The display may automatically activate the HDR function if the player and content are compatible. Please contact the device manufacturer and the content provider for information on the compatibility of your device and content. Please select “OFF” for the HDR function when you have no need for automatical activation function.

Note:

1. No special setting is needed for the DisplayPort/HDMI interface in WIN10 versions lower (older) than V1703.
2. Only the HDMI interface is available and the DisplayPort interface cannot function in WIN10 version V1703.
3. 3840x2160@50Hz/60Hz only suggest for Blu-ray Player, Xbox and PlayStation.
4. Display Setting:
 - a. The display resolution is set to 2560x1440, and HDR is preset to ON.
 - b. After entering an application, the best HDR effect can be achieved when the resolution is changed to 2560x1440 (if available).

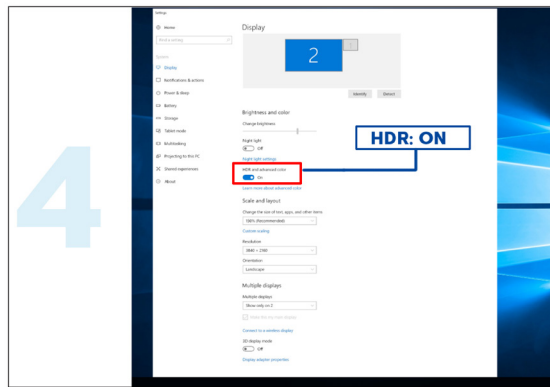
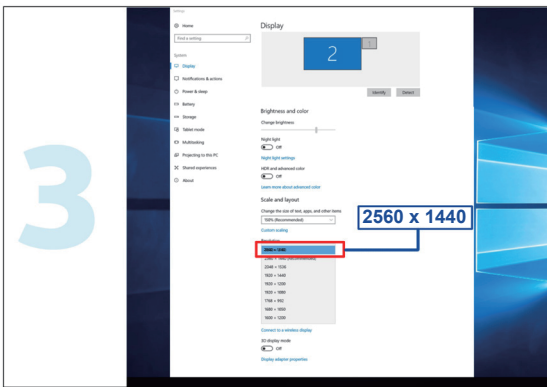
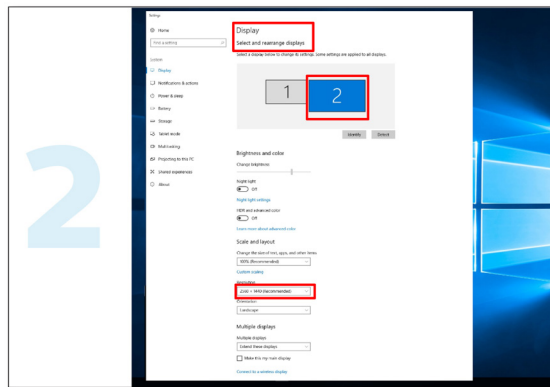
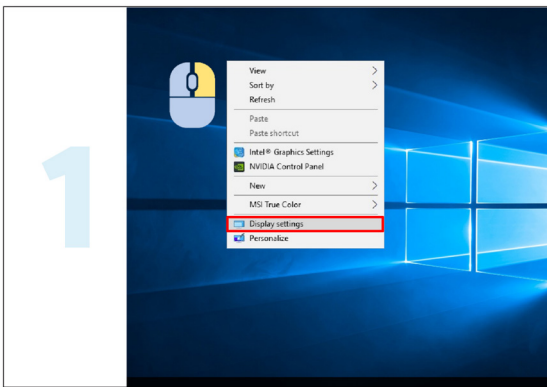

Adjusting

Hotkeys

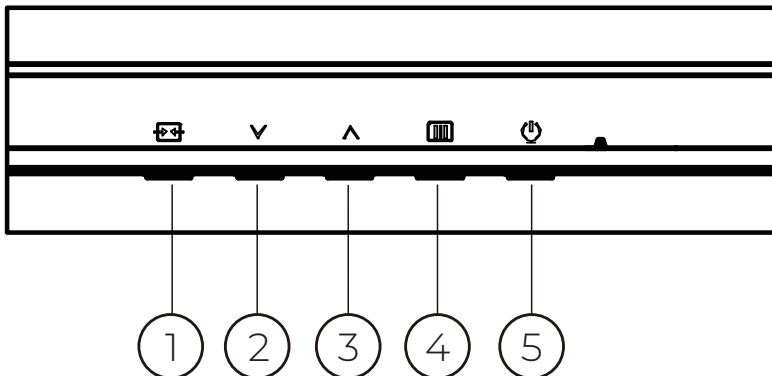

1	Source/Exit
2	User Key(Dual Resolution)/ Decrease
3	Dial Point/Increase
4	Menu/Enter
5	Power

Source/Exit

When the OSD is closed, press Source/Exit button will be Source hot key function.

When the OSD menu is active, this button acts as an exit key (to exit the OSD menu).

User Key(Dual Resolution)/Decrease

User set “**∨**” key shortcut menu: Dual Resolution/Gaming Mode/Frame Counter.

The default is Dual Resolution.

When there is no OSD, press “**∨**” key to open Dual Resolution function, then press “**∨**” or “**∧**” key to select Dual Resolution mode :

OverClock Off
HD 280Hz/QHD 144Hz (HDMI)
HD 400Hz/QHD 240Hz (DisplayPort)
OverClock On
HD 280Hz/QHD 144Hz (HDMI)
HD 400Hz/QHD 260Hz (DisplayPort)

Dial Point/Increase

When there is no OSD, press Dial Point button to show / hide Dial Point.

Menu/Enter

Press to display the OSD or confirm the selection.









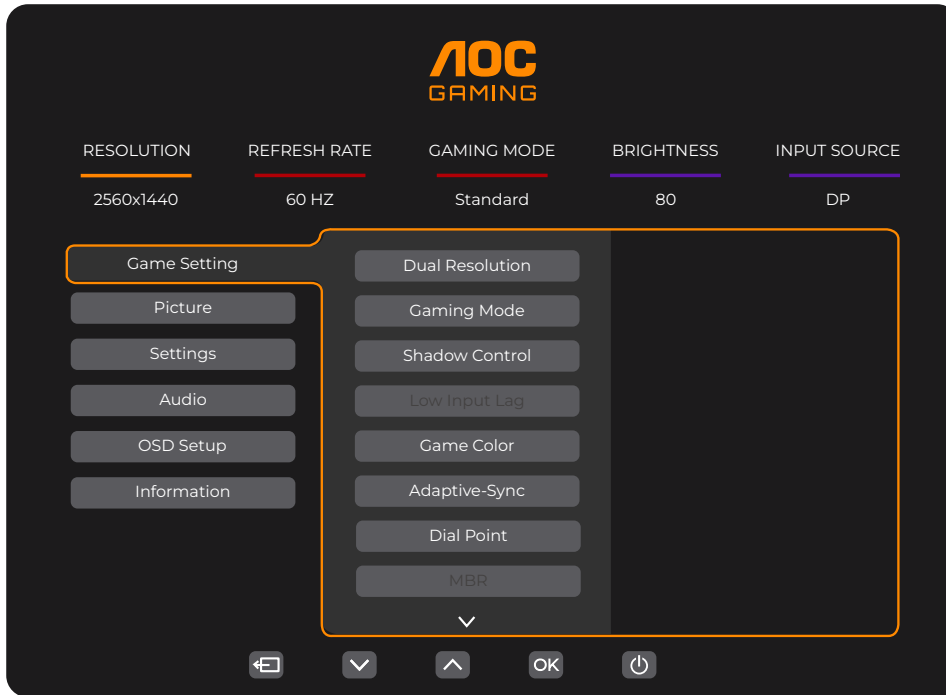





Power

Press the Power button to turn on the monitor.

OSD Setting

Basic and simple instruction on the control keys.



- 1). Press the  MENU-button to activate the OSD window.
- 2). Press  or  to navigate through the functions. Once the desired function is highlighted, press the  MENU-button / OK to activate it, press  or  to navigate through the sub-menu functions. Once the desired sub-menu function is highlighted, press  MENU-button / OK to activate it.
- 3). Press  or  to change the settings of the selected function. Press  /  to exit. If you want to adjust any other function, repeat steps 2-3.
- 4). OSD Lock Function: To lock the OSD, press and hold the  MENU-button while the monitor is off and then press  power button to turn the monitor on. To unlock the OSD - press and hold the  MENU-button while the monitor is off and then press  power button to turn the monitor on.

Game Setting

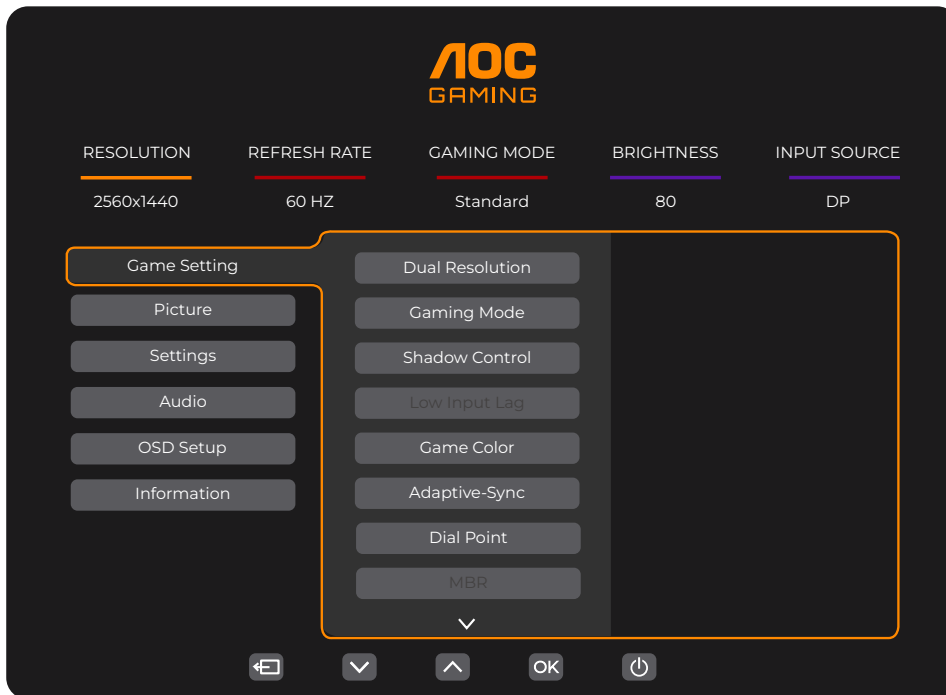

Dual Resolution	OverClock = On HDMI: HD 280Hz / QHD 144Hz DP: HD 400Hz / QHD 260Hz OverClock = Off HDMI: HD 280Hz / QHD 144Hz DP: HD 400Hz / QHD 240Hz	Selected Dual Resolution mode.
Gaming Mode	Standard	Enhance readability for suitable web and mobile games.
	FPS	For playing FPS (first Person Shooters) games. Improves black level in dark theme.
	RTS	For playing RTS (Real Time Strategy) games. Improves the image quality.
	Racing	For playing Racing games, Provides fastest response time and high color saturation.
	Gamer 1	User's preference settings saved as Gamer 1.
	Gamer 2	User's preference settings saved as Gamer 2.
Gamer 3	User's preference settings saved as Gamer 3.	
Shadow Control	0 ~ 20	Shadow Control Default is 0, then end-user can adjust from 0 to 20 increase for a clearer picture. If picture is too dark to be saw the detail clearly, adjusting from 0 to 20 for a clear picture.
Low Input Lag	Off / On	Turn off frame buffer to decrease input lag. Note: When Adaptive-Sync is enabled, The Low Input Lag is enabled by default and cannot be adjusted.
Game Color	0 ~ 20	Game Color will provide 0-20 level for adjusting saturation to get a better picture.
Adaptive-Sync	Off / On	Disable or Enable Adaptive-Sync. Adaptive-Sync Run Reminder: When the Adaptive-Sync feature is enabled, there may be flashing in some game environments.
Dial Point	Off / On / Dynamic	The "Dial Point" function places an aiming indicator in the center of screen for helping gamers to play First Person Shooter (FPS) games with accurate and precise aiming.

MBR	0 ~ 20	MBR (Motion Blur Reduction) Provides 0-20 levels of adjustments to reduce motion blur. Note: The MBR function can be adjusted when Adaptive-Sync is turned off, and the refresh rate $\geq 80\text{Hz}$.
MBR Sync	Off / On	Disable or Enable MBR Sync (Motion Blur Remove). Note: The MBR Sync function can be adjusted when Adaptive-Sync is turned On, and the input signal is variable frequency, and the field frequency is $\geq 75\text{Hz}$.
Overdrive	Normal	Adjust the response time. Note: 1. If the user adjusts OverDrive to "Fastest" the displayed image may be blurred. Users can adjust the OverDrive level or turn it off according to their preferences. 2. The "Extreme" function is optional when Adaptive-Sync is turned off, and the refresh rate is $\geq 80\text{Hz}$. 3. The screen brightness will decrease when the "Extreme" function is turned on.
	Fast	
	Faster	
	Fastest	
	Extreme	
Frame Counter	Off / Right-up / Right-Down / Left-Up / Left-Down	Display V frequency on the corner selected.
OverClock	Off / On	Disable or Enable OverClock.

Note:

- 1). When "HDR Mode" under "Picture" is enable, the items "Shadow Control", "Game Color" cannot be adjusted.
- 2). When "HDR" under "Picture" is set to "DisplayHDR", the items "Gaming Mode", "Shadow Control", "Game Color", "MBR", "MBR Sync" and "Extreme" under "Overdrive" cannot be adjusted.
When "HDR" under "Picture" is set to "HDR Picture", "HDR Movie" or "HDR Game", the items "Gaming Mode", "Game Color", "MBR", "MBR Sync" and "Extreme" under "Overdrive" cannot be adjusted.
- 3). When the "Color Space" under "Picture" is set to "sRGB" or "DCI-P3", the items "Shadow Control", "Game Color", "MBR", "MBR Sync" and "Extreme" under "Overdrive" cannot be adjusted.

Picture

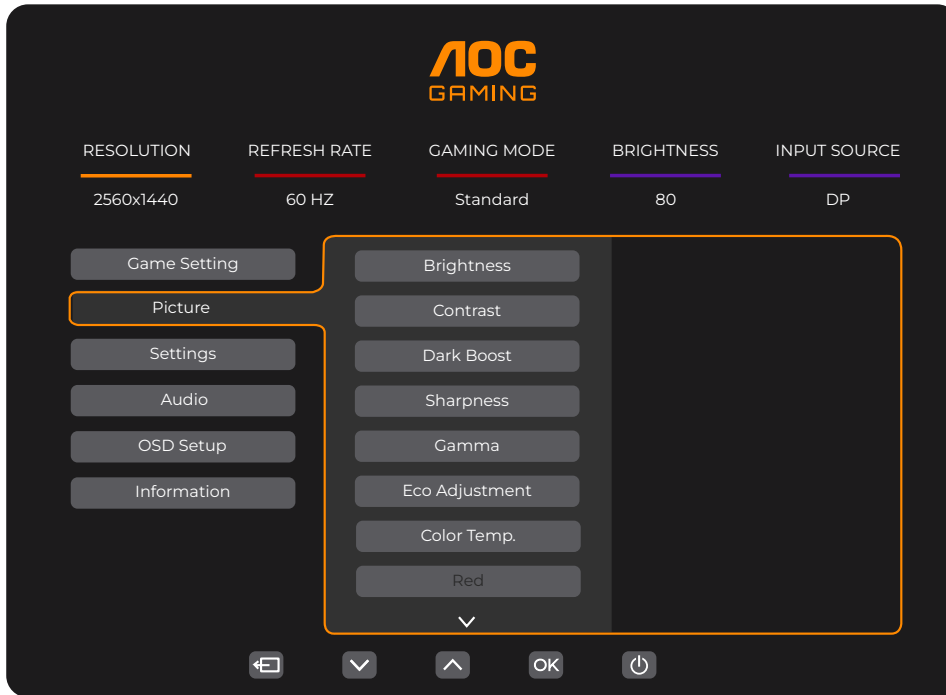

Brightness	0-100	Backlight Adjustment.
Contrast	0-100	Contrast from Digital-register.
Dark Boost	Off / Level 1 / Level 2 / Level 3	Enhance the screen details in the dark or bright area to adjust the brightness in the bright area and ensure that it is not oversaturated.
Sharpness	0-100	Adjust Sharpness.
Gamma	1.8 / 2.0 / 2.2 / 2.4 / 2.6	Adjust Gamma.
Eco Adjustment	Standard	Standard Mode.
	Text	Text Mode.
	Internet	Internet Mode.
	Game	Game Mode.
	Movie	Movie Mode.
	Sports	Sports Mode.
	Reading	Reading Mode.
Color Temp.	Warm	Recall Warm Color Temperature.
	Normal	Recall Normal Color Temperature.
	Cool	Recall Cool Color Temperature.
	User	Restore Color Temperature.
Red	0-100	Red gain from Digital-register.
Green	0-100	Green gain from Digital-register.
Blue	0-100	Blue gain from Digital-register.

R.Saturation	0-100	Adjust R.Saturation.
G.Saturation	0-100	Adjust G.Saturation.
B.Saturation	0-100	Adjust B.Saturation.
C.Saturation	0-100	Adjust C.Saturation.
M.Saturation	0-100	Adjust M.Saturation.
Y.Saturation	0-100	Adjust Y.Saturation.
R.Hue	0-100	Adjust R.Hue.
G.Hue	0-100	Adjust G.Hue.
B.Hue	0-100	Adjust B.Hue.
C.Hue	0-100	Adjust C.Hue.
M.Hue	0-100	Adjust M.Hue.
Y.Hue	0-100	Adjust Y.Hue.
HDR	Off	Set the HDR profile according to your usage requirements. Note: When HDR is detected, the HDR option is displayed for adjustment.
	DisplayHDR	
	HDR Picture	
	HDR Movie	
	HDR Game	
HDR Mode	Off	Optimized for the color and contrast of the picture, which will simulate showing the HDR effect. Note: When HDR is not detected, the HDR Mode option is displayed for adjustment.
	HDR Picture	
	HDR Movie	
	HDR Game	
DCR	Off	Disable dynamic contrast ratio.
	On	Enable dynamic contrast ratio.
Color Space	Panel Native	Standard color space panel.
	sRGB	sRGB Color space.
	DCI-P3	DCI-P3 Color space.
DLBL	Off	Adjust the blue light intensity of each screen zone in real time and dynamically.
	Multimedia	
	Internet	
	Office	
	Reading	
Clear Vision Pro	Off / Level 1 / Level 2 / Level 3 / Level 4	Intelligent adjust sharpness and smoothness.

Image Ratio	Full/ Aspect/ 1:1 / 17"(4:3)/ 19"(4:3)/ 19"(5:4)/ 19"W(16:10)/ 21.5"W(16:9)/ 22"W(16:10)/ 23"W(16:9)/ 23.6"W(16:9)/ 24"W(16:9)	Select image ratio for display.
-------------	---	---------------------------------

Note:

- 1). When "HDR Mode" is enable, the items "Contrast", "Dark Boost", "Gamma", "Eco Adjustment", "Color Temp.", "6-Axis Color Saturation/Hue", "Color Space" and "DLBL" cannot be adjusted.
- 2). When "HDR" is set to "DisplayHDR", all the items under "Picture" except "HDR", "Sharpness", "Clear Vision Pro" cannot be adjusted.
When "HDR" is set to "HDR Picture", "HDR Movie" or "HDR Game", the items "Gamma", "Eco Adjustment", "Color Temp.", "6-Axis Color Saturation/Hue", "DCR", "Color Space" and "DLBL" cannot be adjusted.
- 3). When the "Color Space" is set to "sRGB" or "DCI-P3", the items "Contrast", "Dark Boost", "Gamma", "Eco Adjustment", "Color Temp.", "6-Axis Color Saturation/Hue", "HDR Mode" and "DLBL" cannot be adjusted.
- 4). When the "Eco Adjustment" is set to "Reading", "Contrast", "Dark Boost", "Color Temp.", "6-Axis Color Saturation/Hue", "DCR", "Color Space" and "DLBL" cannot be adjusted.
- 5). When the "Gaming Mode" under "Game Setting" is set to non "Standard" mode, the item "Eco Adjustment", "6-Axis Color Saturation/Hue", "HDR Mode" and "Color Space" cannot be adjusted.
- 6). If the input signal resolution is the native resolution or Adaptive-Sync, then the item "Image Ratio" is invalid.

Settings

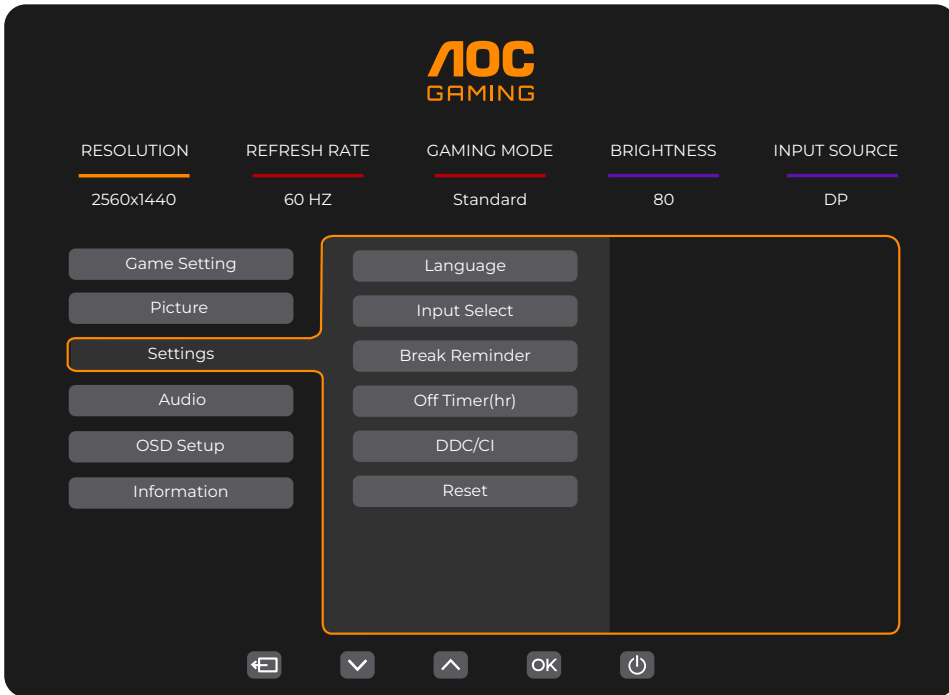

Language		Select the OSD language.
Input Select	Auto / HDMI1 / HDMI2 / DP	Select Input Signal Source.
Break Reminder	Off / On	Break reminder if the user continuously works for more than 1hrs.
Off Timer(hr)	0-24 hrs	Select DC off time.
DDC/CI	No / Yes	Turn On/Off DDC/CI Support.
Reset	No / Yes	Reset the menu to default.

Audio

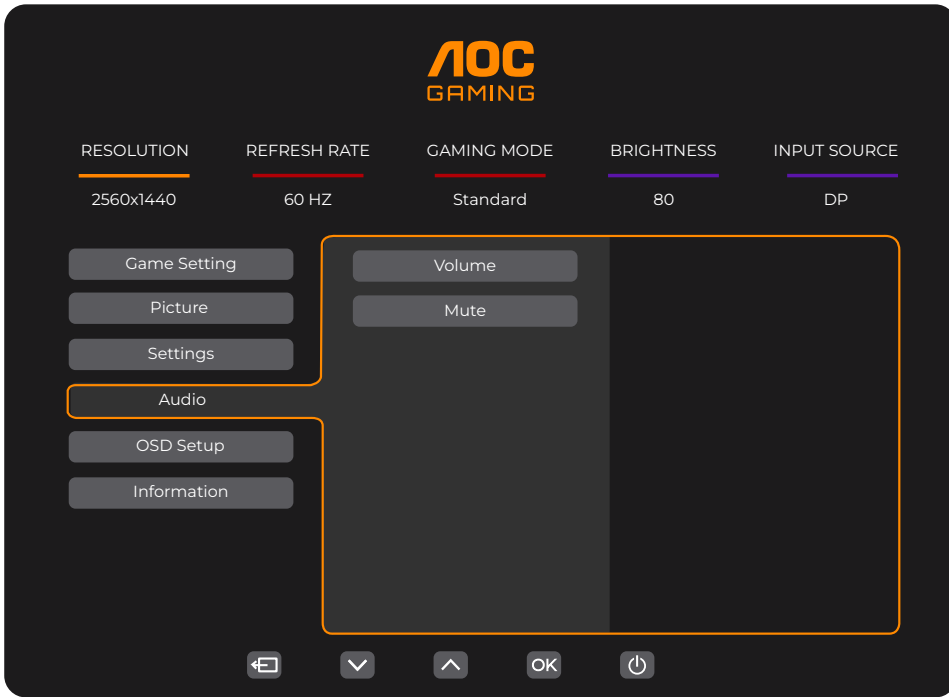

Volume	0-100	Volume Adjustment.
Mute	Off / On	Mute the volume.

OSD Setup

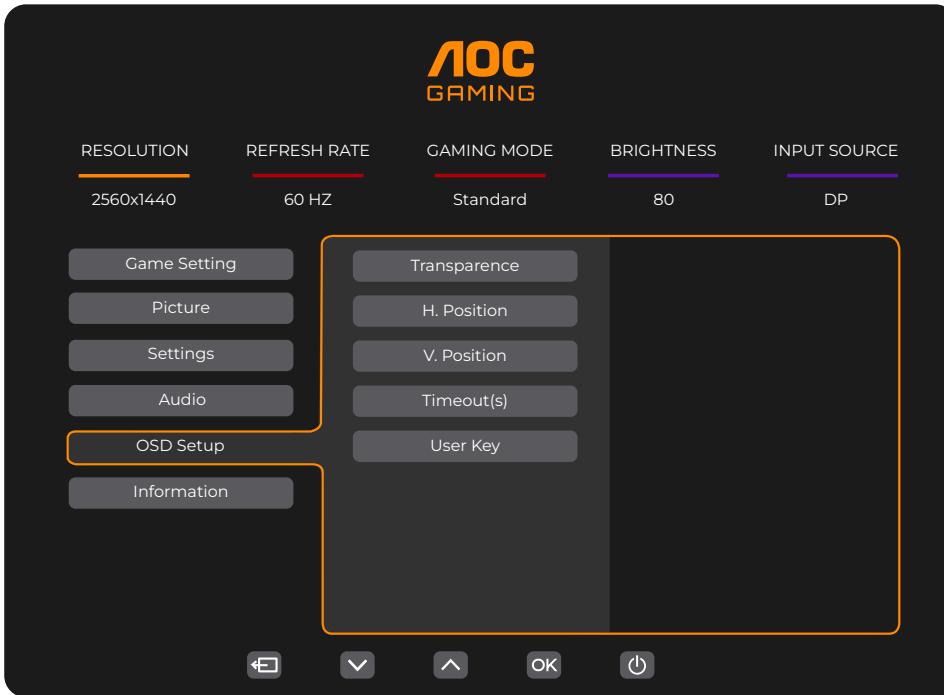

Transparence	0-100	Adjust the transparence of OSD.
H. Position	0-100	Adjust the horizontal position of OSD.
V. Position	0-100	Adjust the vertical position of OSD.
Timeout(s)	5-120	Adjust the OSD Timeout.
User Key	Dual Resolution / Gaming Mode / Frame Counter	User set “√” key shortcut menu.

Information

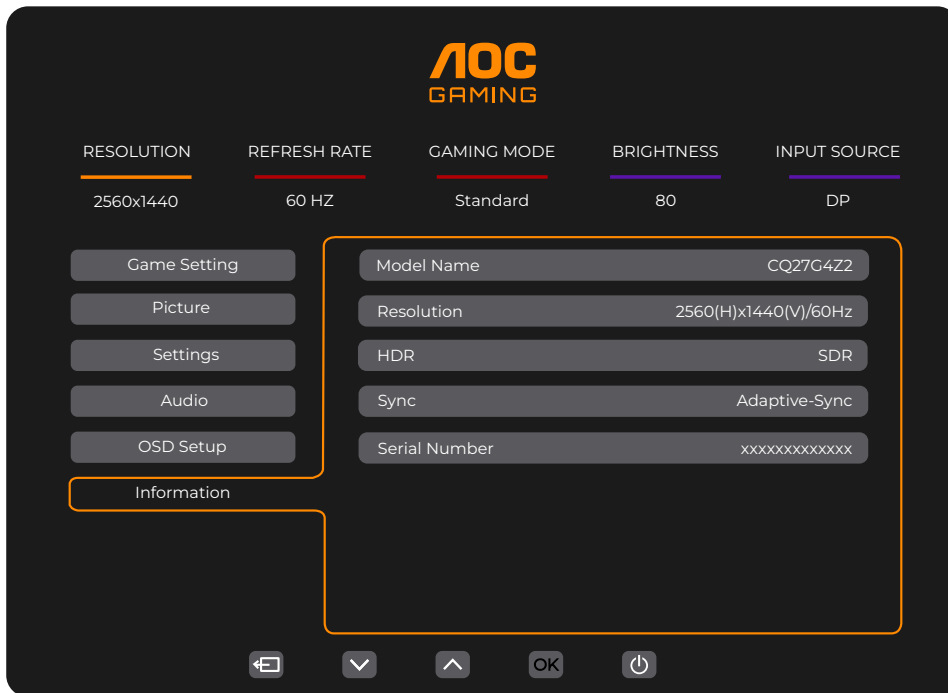

LED Indicator

Status	LED Color
Full Power Mode	White
Active-off Mode	Orange

Troubleshoot

Problem & Question	Possible Solutions
Power LED Is Not ON	Make sure the power button is ON and the Power Cord is properly connected to a grounded power outlet and to the monitor.
No image on the screen	<ul style="list-style-type: none"> ● Is the power cord connected properly? Check the power cord connection and power supply. ● Is the video cable connected correctly? (Connected using the HDMI cable) Check the HDMI cable connection. (Connected using the DisplayPort cable) Check the DisplayPort cable connection. * HDMI/DisplayPort input is not available on every model. ● If the power is on, reboot the computer to see the initial screen (the login screen.) If the initial screen (the login screen) appears, boot the computer in the applicable mode (the safe mode for Windows 7/8/10) and then change the frequency of the video card. (Refer to the Setting the Optimal Resolution) If the initial screen (the login screen) does not appear, contact the Service Center or your dealer. ● Can you see "Input Not Supported" on the screen? You can see this message when the signal from the video card exceeds the maximum resolution and frequency that the monitor can handle properly. Adjust the maximum resolution and frequency that the monitor can handle properly. ● Make sure the AOC Monitor Drivers are installed.
Picture Is Fuzzy & Has Ghosting Shadowing Problem	Adjust the Contrast and Brightness Controls. Press hot-key (AUTO) to auto-adjust. Make sure you are not using an extension cable or switch box. We recommend plugging the monitor directly to the video card output connector on the back.
Picture Bounces, Flickers Or Wave Pattern Appears In The Picture	Move electrical devices that may cause electrical interference as far away from the monitor as possible. Use the maximum refresh rate your monitor is capable of at the resolution you are using.
Monitor Is Stuck In Active Off-Mode"	The Computer Power Switch should be in the ON position. The Computer Video Card should be snugly fitted in its slot. Make sure the monitor's video cable is properly connected to the computer. Inspect the monitor's video cable and make sure no pin is bent. Make sure your computer is operational by hitting the CAPS LOCK key on the keyboard while observing the CAPS LOCK LED. The LED should either turn ON or OFF after hitting the CAPS LOCK key.
Missing one of the primary colors (RED, GREEN, or BLUE)	Inspect the monitor's video cable and make sure that no pin is damaged. Make sure the monitor's video cable is properly connected to the computer.
Screen image is not centered or sized properly	Adjust H-Position and V-Position or press hot-key (AUTO).
Picture has color defects (white does not look white)	Adjust RGB color or select desired color temperature.
Horizontal or vertical disturbances on the screen	Use Windows 7/8/10/11 shut-down mode to adjust CLOCK and FOCUS. Press hot-key (AUTO) to auto-adjust.
Regulation & Service	Please refer to Regulation & Service Information at www.aoc.com (to find the model you purchase in your country and to find Regulation & Service Information in Support page.)

Specification

General Specification

Panel	Model name	CQ27G4Z2		
	Driving system	TFT Color LCD		
	Viewable Image Size	68.5 cm diagonal		
	Pixel pitch	0.2331mm(H)x 0.2331mm(V)		
	Display Color	1.07B Colors ^[1]		
Others	Horizontal scan range	HD:30k~230kHz (HDMI) 30k~310kHz (DisplayPort) QHD:30k~230kHz (HDMI) 30k~400kHz (DisplayPort)		
	Horizontal scan Size(Maximum)	596.736mm		
	Vertical scan range	HD:48~280Hz (HDMI) 48~400Hz (DisplayPort) QHD:48~144Hz (HDMI) 48~260Hz (DisplayPort)		
	Vertical Scan Size(Maximum)	335.664mm		
	Optimal preset resolution	HD:1280x720@60Hz QHD:2560x1440@60Hz		
	Max resolution	HD:1280x720@280Hz (HDMI) 1280x720@400Hz (DisplayPort) QHD:2560x1440@144Hz (HDMI) 2560x1440@260Hz ^[2] (DisplayPort)		
	Plug & Play	VESA DDC2B/CI		
	Connector Type	HDMIx2/DisplayPort/Earphone		
	Power Source	100-240V ~ 50/60Hz 1.5A		
	Power Consumption	Typical(default brightness and contrast)	25W	
		Max. (brightness = 100, contrast =100)	≤51W	
		Standby Mode	≤0.5W	
	Heat Dissipation	Normal Operation	85.32 BTU/hr (typ.)	
		Sleep (Standby mode)	<1.71 BTU/hr	
Off mode		<1.71 BTU/hr		
Off mode(AC switch)		0 BTU/hr		
Environmental	Temperature	Operating	0°C~40°C	
		Non-Operating	-25°C~55°C	
	Humidity	Operating	10%~85% (Non-Condensing)	
		Non-Operating	5%~93% (Non-Condensing)	
	Altitude	Operating	0m~5000m (0ft~16404ft)	
		Non-Operating	0m~12192m (0ft~40000ft)	

Note:

[1]The maximum number of display colors supported by this product is 1.07 billion, and the setting conditions are as follows (there may be differences due to the output limitation of some graphics cards)

("V":support, "\":nonsupport):

Color Bit	Signal Version	HDMI2.1 TMDS		DisplayPort1.4	
	Color Format	YCbCr420	YCbCr444	YCbCr420	YCbCr444
	State	YCbCr422	RGB	YCbCr422	RGB

2560x1440 OC 260Hz 10 bit	\	\	✓	\
2560x1440 OC 260Hz 8 bit	\	\	✓	✓
2560x1440 240Hz 10 bit	\	\	✓	\
2560x1440 240Hz 8 bit	\	\	✓	✓
2560x1440 200Hz 10 bit	\	\	✓	✓
2560x1440 200Hz 8bit	\	\	✓	✓
2560x1440 180Hz 10 bit	\	\	✓	✓
2560x1440 180Hz 8 bit	\	\	✓	✓
2560x1440 165Hz 10 bit	\	\	✓	✓
2560x1440 165Hz 8 bit	\	\	✓	✓
2560x1440 144Hz 10 bit	✓	\	✓	✓
2560x1440 144Hz 8 bit	✓	✓	✓	✓
2560x1440 120Hz 10 bit	✓	\	✓	✓
2560x1440 120Hz 8 bit	✓	✓	✓	✓
2560x1440 100Hz 10 bit	✓	✓	✓	✓
2560x1440 100Hz 8 bit	✓	✓	✓	✓
2560x1440 75Hz 10 bit	\	\	✓	✓
2560x1440 75Hz 8 bit	\	\	✓	✓
2560x1440 60Hz 10 bit	✓	✓	✓	✓
2560x1440 60Hz 8 bit	✓	✓	✓	✓
1280x720 OC 440Hz 10 bit	\	\	✓	✓
1280x720 OC 440Hz 8 bit	\	\	✓	✓
1280x720 400Hz 10 bit	\	\	✓	✓
1280x720 400Hz 8 bit	\	\	✓	✓
1280x720 320Hz 10 bit	\	\	✓	✓
1280x720 320Hz 8 bit	\	\	✓	✓
1280x720 280Hz 10 bit	✓	✓	\	\
1280x720 280Hz 8 bit	✓	✓	\	\
1280x720 240Hz 10 bit	✓	✓	✓	✓
1280x720 240Hz 8 bit	✓	✓	✓	✓
1280x720 144Hz 10 bit	✓	✓	✓	✓
1280x720 144Hz 8 bit	✓	✓	✓	✓
1280x720 60Hz 10 bit	✓	✓	✓	✓
1280x720 60Hz 8 bit	✓	✓	✓	✓

[2]Overclocking is achieved when resolution is at 2560x1440@260Hz. If any display error occurs during overclocking, please adjust the refresh rate to 240Hz.



AOC Monitors Panel Pixel Defect Policy

AOC strives to deliver the highest quality products. We use some of the industry's most advanced manufacturing processes and practice stringent quality control. However, pixel or sub pixel defects on the Monitor panels used in the monitors are sometimes unavoidable.

No manufacturer can guarantee that all panels will be free from pixel defects, but AOC guarantees that any monitor with an unacceptable number of defects will be repaired or replaced under warranty. This notice explains the different types of pixel defects and defines acceptable defect levels for each type. In order to qualify for repair or replacement under warranty, the number of pixel defects on a Monitor panel must exceed these acceptable levels. For example, no more than 0.0004% of the sub pixels on a monitor may be defective.

Furthermore, AOC sets even higher quality standards for certain types or combinations of pixel defects that are more noticeable than others. This policy is valid worldwide.

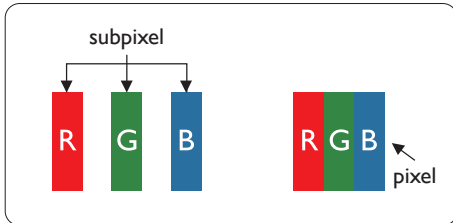

Pixels and Sub pixels

A pixel, or picture element, is composed of three sub pixels in the primary colors of red, green and blue. Many pixels together form an image. When all sub pixels of a pixel are lit, the three colored sub pixels together appear as a single white pixel. When all are dark, the three colored sub pixels together appear as a single black pixel. Other combinations of lit and dark sub pixels appear as single pixels of other colors.

Types of Pixel Defects

Pixel and sub pixel defects appear on the screen in different ways. There are two categories of pixel defects and several types of sub pixel defects within each category.

Bright Dot Defects

Bright dot defects appear as pixels or sub pixels that are always lit or 'on'. That is, a bright dot is a sub-pixel that stands out on the screen when the monitor displays a dark pattern. There are the types of bright dot defects.

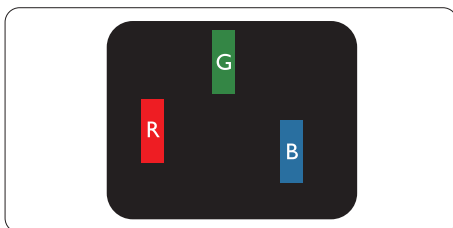

One lit red, green or blue sub pixel.

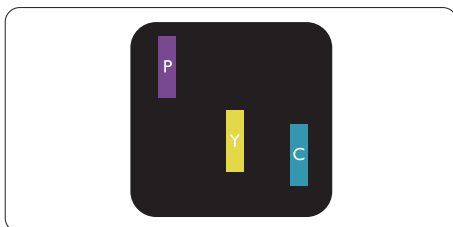

Two adjacent lit sub pixels:

- Red + Blue = Purple
- Red + Green = Yellow
- Green + Blue = Cyan (Light Blue)



Three adjacent lit sub pixels (one white pixel).

Note

A red or blue bright dot must be more than 50 percent brighter than neighboring dots while a green bright dot is 30 percent brighter than neighboring dots.

Black Dot Defects

Black dot defects appear as pixels or sub pixels that are always dark or 'off'. That is, a dark dot is a sub-pixel that stands out on the screen when the monitor displays a light pattern. These are the types of black dot defects.

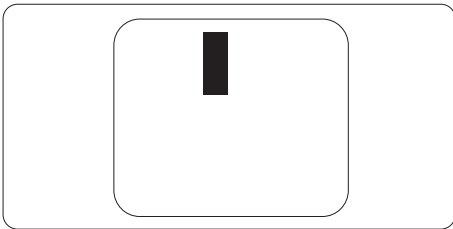

Proximity of Pixel Defects

Because pixel and sub pixels defects of the same type that are near to one another may be more noticeable, AOC also specifies tolerances for the proximity of pixel defects.

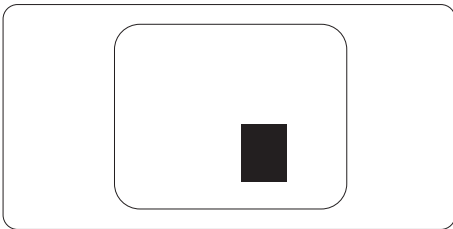

Pixel Defect Tolerances

In order to qualify for repair or replacement due to pixel defects during the warranty period, a Monitor panel in a AOC panel monitor must have pixel or sub pixel defects exceeding the tolerances listed in the web manual.

BRIGHT DOT DEFECTS	ACCEPTABLE LEVEL
1 lit subpixel	2
2 adjacent lit subpixels	1
3 adjacent lit subpixels (one white pixel)	0
Distance between two bright dot defects*	≥15mm
Total bright dot defects of all types	2
BLACK DOT DEFECTS	ACCEPTABLE LEVEL
1 dark subpixel	5 or fewer
2 adjacent dark subpixels	2 or fewer
3 adjacent dark subpixels	≤0
Distance between two black dot defects*	≥15mm
Total black dot defects of all types	5 or fewer
TOTAL DOT DEFECTS	ACCEPTABLE LEVEL
Total bright or black dot defects of all types	5 or fewer

Note

*: 1 or 2 adjacent sub pixel defects = 1 dot defect.

Preset Display Modes

STANDARD	RESOLUTION(±1Hz)	HORIZONTAL FREQUENCY(KHz)	VERTICAL FREQUENCY(Hz)
VGA	640×480@60Hz	31.469	59.94
	640×480@67Hz	35	66.667
	640×480@72Hz	37.861	72.809
	640×480@75Hz	37.5	75
	640×480@100Hz	51.08	99.769
	640×480@120Hz	61.91	119.51
DOS MODE	720×400@70Hz	31.469	70.087
SVGA	800×600@56Hz	35.156	56.25
	800×600@60Hz	37.879	60.317
	800×600@72Hz	48.077	72.188
	800×600@75Hz	46.875	75
	800×600@100Hz	63.68	99.662
	800×600@120Hz	77.43	119.854
	832×624@75Hz	49.725	74.551
HD	1280×720@60Hz	45.59	59.987
	1280×720@144Hz	109.438	143.997
	1280×720@240Hz	182.403	240.004
	1280×720@280Hz	212.799	279.998
	1280×720@320Hz	243.188	319.984
	1280×720@400Hz	303.993	399.991
XGA	1024×768@60Hz	48.363	60.004
	1024×768@70Hz	56.476	70.069
	1024×768@75Hz	60.023	75.029
	1024×768@100Hz	81.577	99.972
	1024×768@120Hz	97.551	119.989
	1280×1024@60Hz	63.981	60.02
	1280×1024@75Hz	79.976	75.025
QHD	2560×1440@60Hz	88.86	60
	2560×1440@100Hz	151	100
	2560×1440@120Hz	182.996	119.998
	2560×1440@144Hz	214.563	144.002
	2560×1440@165Hz	247.667	165.001
	2560×1440@180Hz	268.739	179.999
	2560×1440@200Hz	300.199	199.999
	2560×1440@240Hz	360.243	240.002
	2560×1440@260Hz	384.792	259.995

Note: According to the VESA standard, there may be a certain error (+/-1Hz) when calculating the refresh rate (field frequency) of different operating systems and graphics cards. In order to improve compatibility, the nominal refresh rate of this product has been rounded off. Please refer to the actual product.

Pin Assignments



19-Pin Color Display Signal Cable

Pin No.	Signal Name	Pin No.	Signal Name	Pin No.	Signal Name
1.	TMDS Data 2+	9.	TMDS Data 0-	17.	DDC/CEC Ground
2.	TMDS Data 2 Shield	10.	TMDS Clock +	18.	+5V Power
3.	TMDS Data 2-	11.	TMDS Clock Shield	19.	Hot Plug Detect
4.	TMDS Data 1+	12.	TMDS Clock-		
5.	TMDS Data 1Shield	13.	CEC		
6.	TMDS Data 1-	14.	Reserved (N.C. on device)		
7.	TMDS Data 0+	15.	SCL		
8.	TMDS Data 0 Shield	16.	SDA		

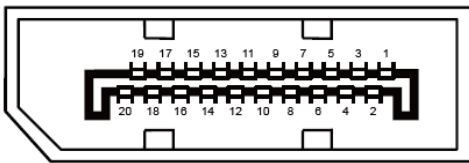

20-Pin Color Display Signal Cable

Pin No.	Signal Name	Pin No.	Signal Name
1	ML_Lane 3 (n)	11	GND
2	GND	12	ML_Lane 0 (p)
3	ML_Lane 3 (p)	13	CONFIG1
4	ML_Lane 2 (n)	14	CONFIG2
5	GND	15	AUX_CH(p)
6	ML_Lane 2 (p)	16	GND
7	ML_Lane 1 (n)	17	AUX_CH(n)
8	GND	18	Hot Plug Detect
9	ML_Lane 1 (p)	19	Return DP_PWR
10	ML_Lane 0 (n)	20	DP_PWR

Plug and Play

Plug & Play DDC2B Feature

This monitor is equipped with VESA DDC2B capabilities according to the VESA DDC STANDARD. It allows the monitor to inform the host system of its identity and, depending on the level of DDC used, communicate additional information about its display capabilities.

The DDC2B is a bi-directional data channel based on the I2C protocol. The host can request EDID information over the DDC2B channel.

