

# USER MANUAL



## CU34B3E

AOC.COM

©2025 AOC. All rights reserved

Version: A00

**AOC**

Safety.....	1
National Conventions .....	1
Power.....	2
Installation .....	3
Cleaning.....	4
Other.....	5
Setup .....	6
Contents in Box.....	6
Set-up Stand & Base .....	7
Adjusting Viewing Angle .....	8
Connecting the Monitor .....	9
Wall Mounting .....	10
Adaptive-Sync function.....	11
HDR.....	12
Adjusting .....	13
Hotkeys.....	13
OSD Setting .....	14
Game Setting .....	15
Preset Mode.....	16
Picture.....	17
Input.....	19
PIP/PBP .....	20
Settings.....	22
Audio.....	23
OSD Setup .....	24
Information .....	25
LED Indicator .....	26
Troubleshoot.....	27
Specification .....	28
General Specification.....	28
AOC Monitors Panel Pixel Defect Policy.....	29
Preset Display Modes .....	31
Pin Assignments.....	32
Plug and Play .....	33

# Safety

## National Conventions

The following subsections describe national conventions used in this document.

### Notes, Cautions, and Warnings

Throughout this guide, blocks of text may be accompanied by an icon and printed in bold type or in italic type. These blocks are notes, cautions, and warnings, and they are used as follows:



**NOTE:** A NOTE indicates important information that helps you make better use of your computer system.





**CAUTION:** A CAUTION indicates either potential damage to hardware or loss of data and tells you how to avoid the problem.



**WARNING:** A WARNING indicates the potential for bodily harm and tells you how to avoid the problem. Some warnings may appear in alternate formats and may be unaccompanied by an icon. In such cases, the specific presentation of the warning is mandated by regulatory authority.

## Power

 The monitor should be operated only from the type of power source indicated on the label. If you are not sure of the type of power supplied to your home, consult your dealer or local power company.

 The monitor is equipped with a three-pronged grounded plug, a plug with a third (grounding) pin. This plug will fit only into a grounded power outlet as a safety feature. If your outlet does not accommodate the three-wire plug, have an electrician install the correct outlet, or use an adapter to ground the appliance safely. Do not defeat the safety purpose of the grounded plug.

 Unplug the unit during a lightning storm or when it will not be used for long periods of time. This will protect the monitor from damage due to power surges.

 Do not overload power strips and extension cords. Overloading can result in fire or electric shock.

 To ensure satisfactory operation, use the monitor only with UL listed computers which have appropriate configured receptacles marked between 100-240V AC, Min. 5A.

 The wall socket shall be installed near the equipment and shall be easily accessible.

# Installation

**!** Do not place the monitor on an unstable cart, stand, tripod, bracket, or table. If the monitor falls, it can injure a person and cause serious damage to this product. Use only a cart, stand, tripod, bracket, or table recommended by the manufacturer or sold with this product. Follow the manufacturer's instructions when installing the product and use mounting accessories recommended by the manufacturer. A product and cart combination should be moved with care.

**!** Never push any object into the slot on the monitor cabinet. It could damage circuit parts causing a fire or electric shock. Never spill liquids on the monitor.

**!** Do not place the front of the product on the floor.

**!** If you mount the monitor on a wall or shelf, use a mounting kit approved by the manufacturer and follow the kit instructions.

**!** Leave some space around the monitor as shown below. Otherwise, air-circulation may be inadequate hence overheating may cause a fire or damage to the monitor.

**!** To avoid potential damage, for example the panel peeling from the bezel, ensure that the monitor does not tilt downward by more than -5 degrees. If the -5 degree downward tilt angle maximum is exceeded, the monitor damage will not be covered under warranty.

See below the recommended ventilation areas around the monitor when the monitor is installed on the wall or on the stand:

## Installed with stand

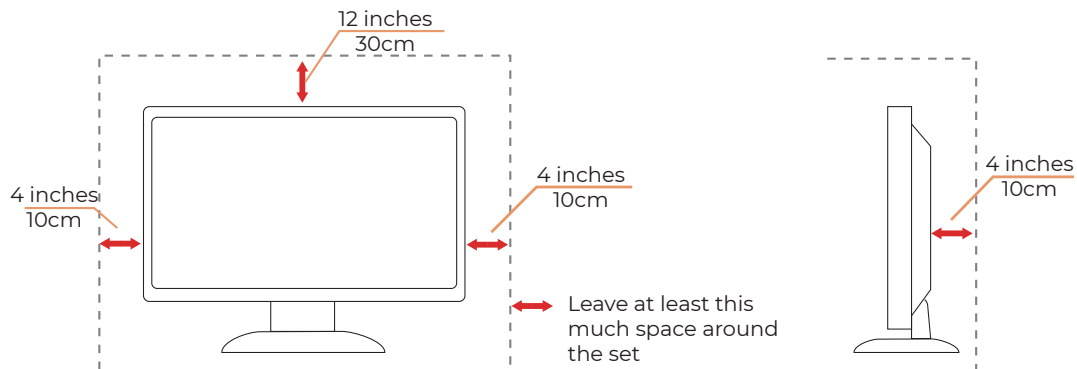

# Cleaning

⚠ Clean the cabinet regularly with a water-dampened, soft cloth.

⚠ When cleaning use a soft cotton or microfiber cloth. The cloth should be damp and almost dry, do not allow liquid into the case.



⚠ Please disconnect the power cord before cleaning the product.

## Other

 If the product is emitting a strange smell, sound or smoke, disconnect the power plug IMMEDIATELY and contact a Service Center.

 Make sure that the ventilating openings are not blocked by a table or curtain.

 Do not engage the LCD monitor in severe vibration or high impact conditions during operation.

 Do not knock or drop the monitor during operation or transportation.

 The power cords shall be safety approved. For Germany, it shall be H03VV-F, 3G, 0.75 mm<sup>2</sup>, or better. For other countries, the suitable types shall be used accordingly.

 Excessive sound pressure from earphones and headphones can cause hearing loss. Adjustment of the equalizer to maximum increases the earphones and headphones output voltage and therefore the sound pressure level.

# Setup

## Contents in Box

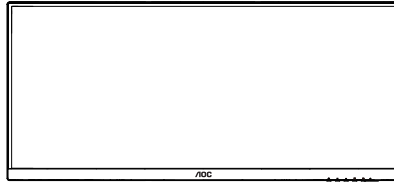

Monitor



Quick Start Guide



Warranty Card



Stand



Base



Screws



Screws



Power Cable



HDMI Cable



DisplayPort Cable

\*Not all signal cables will be provided for all countries and regions. Please check with the local dealer or AOC branch office for confirmation.



# Set-up Stand & Base

Please setup or remove the base following the steps as below.

## Setup:

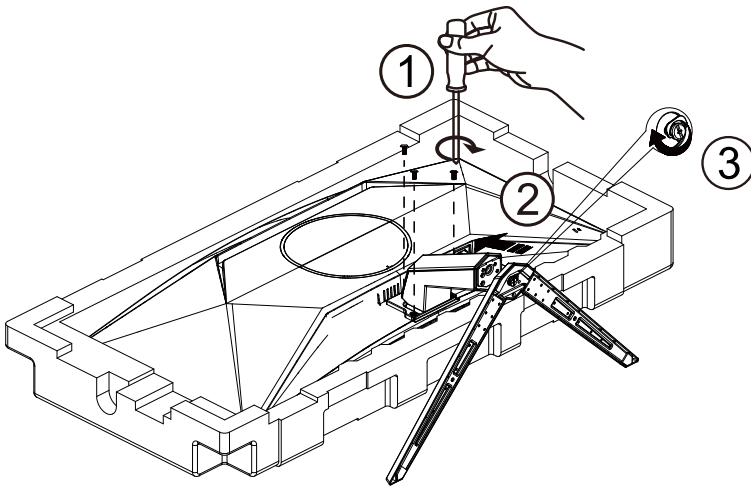

## Remove:

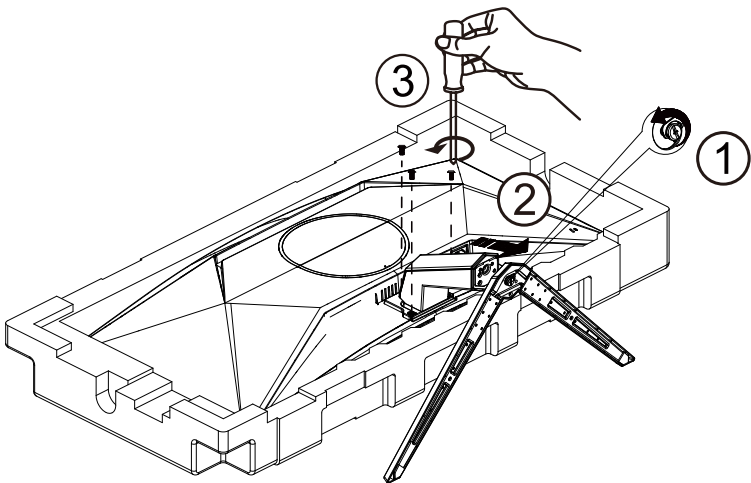

 **NOTE:** Display design may differ from those illustrated.

## Adjusting Viewing Angle

To achieve the best viewing experience, it is recommended that the user can make sure they are able to look at their whole face on the screen, then adjust the monitor's angle based on personal preference.

Hold the stand so you will not topple the monitor when you change the monitor's angle.

You are able to adjust the monitor as below:

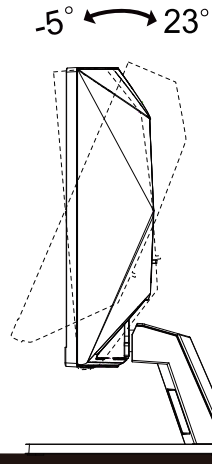

### NOTE:

Do not touch the LCD screen when you change the angle. Touching the LCD screen may cause damage.

### Warning

- To avoid potential screen damage, such as panel peeling, ensure that the monitor does not tilt downward by more than -5 degrees.
- Do not press the screen while adjusting the angle of the monitor. Grasp only the bezel.

# Connecting the Monitor

Cable Connections In Back of Monitor and Computer:

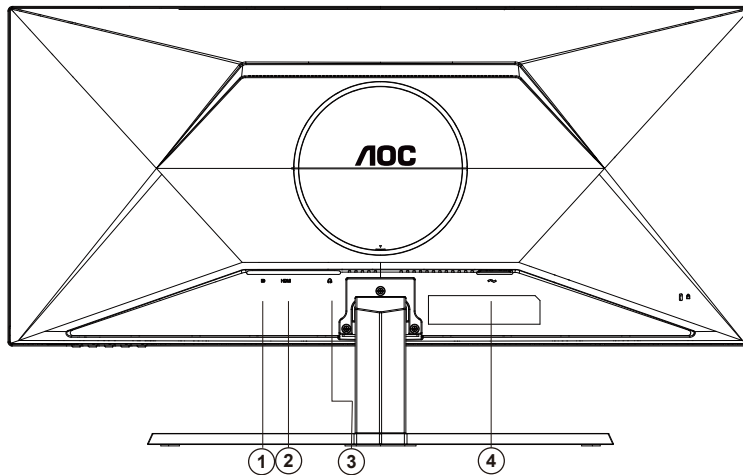

1. DisplayPort
2. HDMI
3. Earphone
4. Power

## Connect to PC

1. Connect the power cord to the back of the display firmly.
2. Turn off your computer and unplug its power cable.
3. Connect the display signal cable to the video connector on the back of your computer.
4. Plug the power cord of your computer and your display into a nearby outlet.
5. Turn on your computer and display.

If your monitor displays an image, installation is complete. If it does not display an image, please refer to Troubleshoot.

To protect equipment, always turn off the PC and LCD monitor before connecting.

# Wall Mounting

Preparing to Install An Optional Wall Mounting Arm.

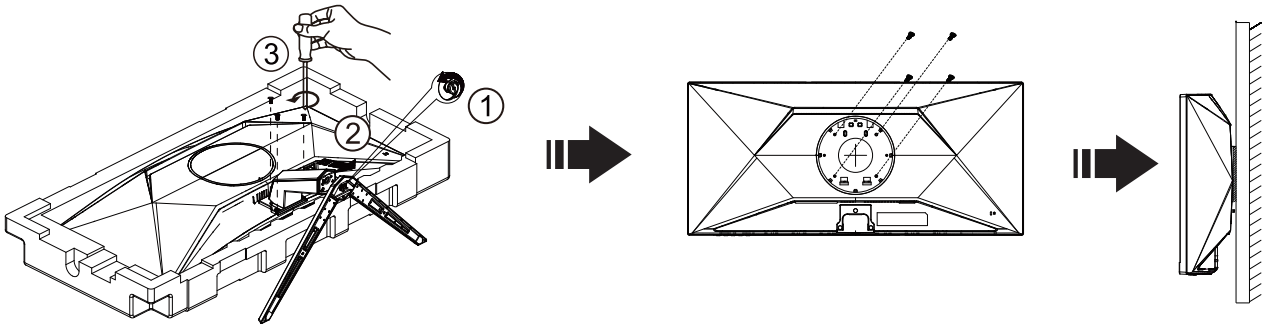

This monitor can be attached to a wall mounting arm you purchase separately. Disconnect power before this procedure. Follow these steps:

1. Remove the base.
2. Follow the manufacturer's instructions to assemble the wall mounting arm.
3. Place the wall mounting arm onto the back of the monitor. Line up the holes of the arm with the holes in the back of the monitor.
4. Insert the 4 screws into the holes and tighten.
5. Reconnect the cables. Refer to the user's manual that came with the optional wall mounting arm for instructions on attaching it to the wall.

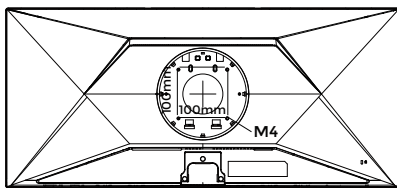

Specification of wall hanger screws: M4\*(10+X)mm (X=Thickness of Wall mount bracket)

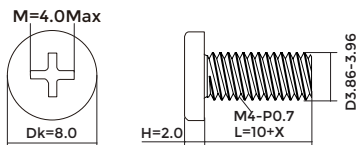

**Note:** VESA mounting screw holes are not available for all models, please check with the dealer or official department of AOC. Always contact manufacturer for wall-mount installation.

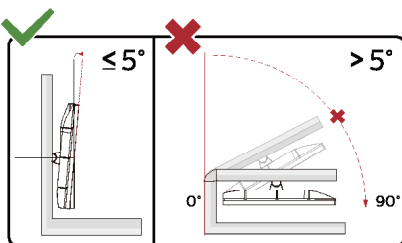

\* Display design may differ from those illustrated.

## ⚠WARNING:

1. To avoid potential screen damage, such as panel peeling, ensure that the monitor does not tilt downward by more than -5 degrees.
2. Do not press the screen while adjusting the angle of the monitor. Grasp only the bezel.

# Adaptive-Sync function

1. Adaptive-Sync function works with HDMI/DisplayPort
2. Compatible Graphics Card: Recommended list is as below, also could be checked by visiting [www.AMD.com](http://www.AMD.com)

## Graphics Cards

- Radeon™ RX Vega series
- Radeon™ RX 500 series
- Radeon™ RX 400 series
- Radeon™ R9/R7 300 series (R9 370/X, R7 370/X, R7 265 except)
- Radeon™ Pro Duo (2016)
- Radeon™ R9 Nano series
- Radeon™ R9 Fury series
- Radeon™ R9/R7 200 series (R9 270/X, R9 280/X except)

## Processors

- AMD Ryzen™ 7 2700U
- AMD Ryzen™ 5 2500U
- AMD Ryzen™ 5 2400G
- AMD Ryzen™ 3 2300U
- AMD Ryzen™ 3 2200G
- AMD PRO A12-9800
- AMD PRO A12-9800E
- AMD PRO A10-9700
- AMD PRO A10-9700E
- AMD PRO A8-9600
- AMD PRO A6-9500
- AMD PRO A6-9500E
- AMD PRO A12-8870
- AMD PRO A12-8870E
- AMD PRO A10-8770
- AMD PRO A10-8770E
- AMD PRO A10-8750B
- AMD PRO A8-8650B
- AMD PRO A6-8570
- AMD PRO A6-8570E
- AMD PRO A4-8350B
- AMD A10-7890K
- AMD A10-7870K
- AMD A10-7850K
- AMD A10-7800
- AMD A10-7700K
- AMD A8-7670K
- AMD A8-7650K
- AMD A8-7600
- AMD A6-7400K

# HDR

It is compatible with input signals in HDR10 format.

The display may automatically activate the HDR function if the player and content are compatible. Please contact the device manufacturer and the content provider for information on the compatibility of your device and content. Please select "OFF" for the HDR function when you have no need for automatical activation function.

## Note:

1. No special setting is needed for the DisplayPort/HDMI interface in WIN10 versions lower (older) than V1703.
2. Only the HDMI interface is available and the DisplayPort interface cannot function in WIN10 version V1703.
3. 3840x2160 only suggest for Blu-ray Player, Xbox and PlayStation.
  - a. The display resolution is set to 3440\*1440, and HDR is preset to ON.
  - b. After entering an application, the best HDR effect can be achieved when the resolution is changed to 3440\*1440 (if available).

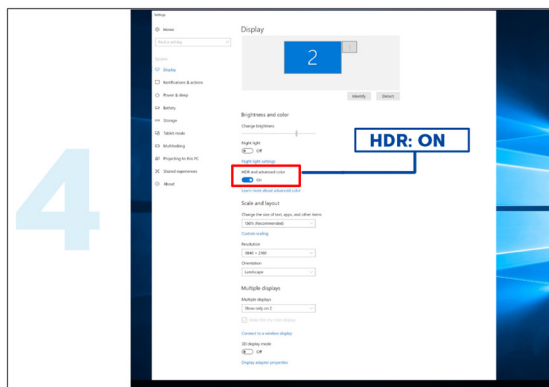
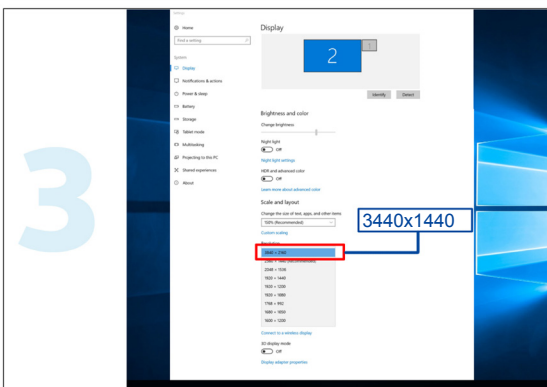
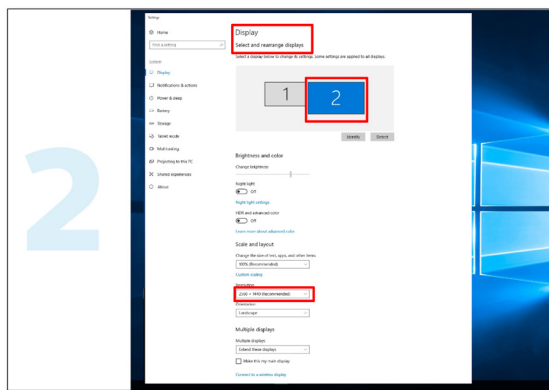
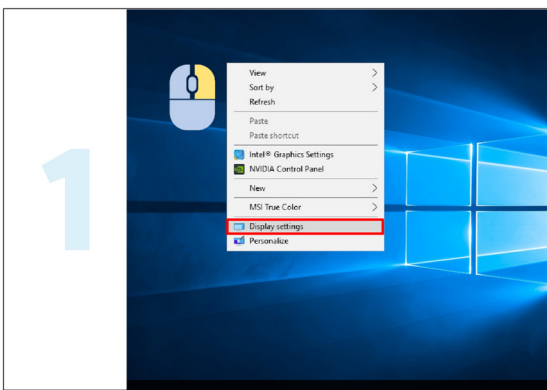

# Adjusting

## Hotkeys

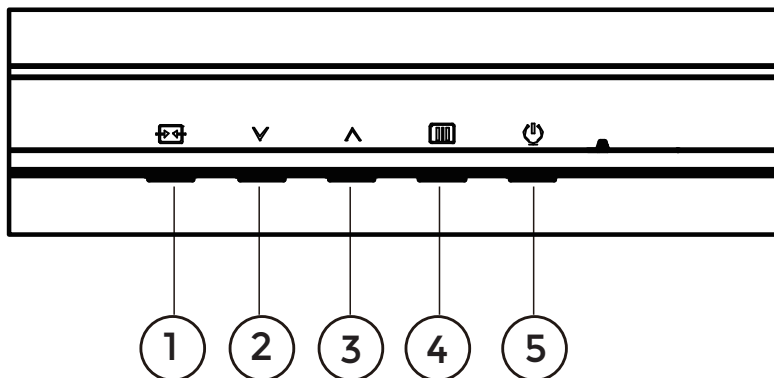

1	Source/Exit
2	Preset Mode/∇
3	Brightness/∧
4	Menu/Enter
5	Power

### Menu/Enter

Press to display the OSD or confirm the selection.

### Power

Press the Power button to turn on the monitor.

### Preset Mode/∇

When there is no OSD, press “∇” key to open Preset Mode function, then press “∇” or “∧” key to select Preset Mode.

### Brightness/∧

When there is no OSD, press “∧” key to open Brightness function, then press “∧” or “∇” key to adjust the brightness.

### Source/Exit

When the OSD is closed, press Source/Exit button will be Source hot key function.

When the OSD menu is active, this button acts as an exit key (to exit the OSD menu).

# OSD Setting

Basic and simple instruction on the control keys.

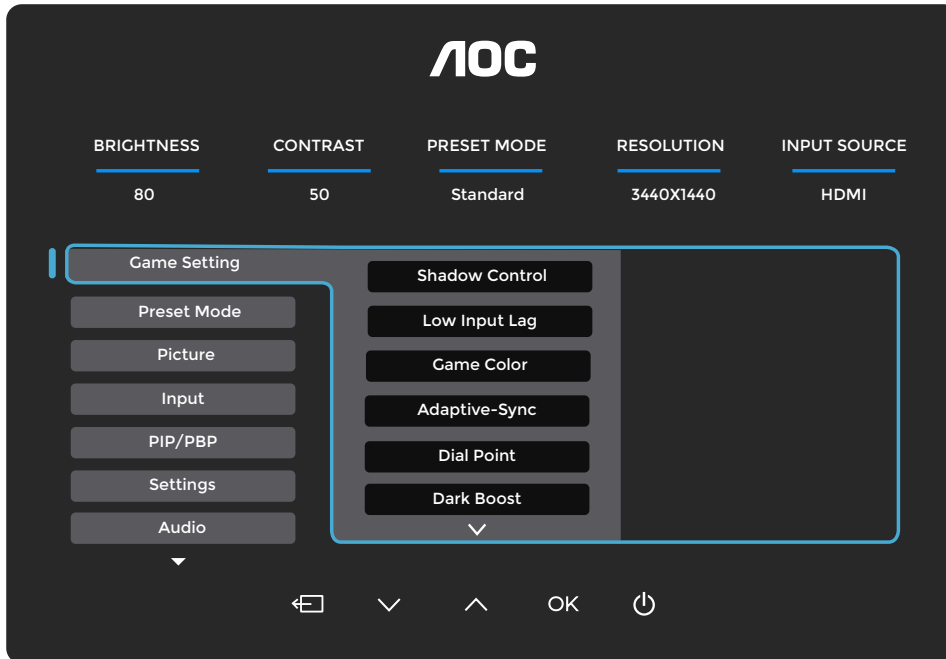

- 1). Press the **MENU-button** to activate the OSD window.
- 2). Press  $\downarrow$  or  $\uparrow$  to navigate through the functions. Once the desired function is highlighted, press the **MENU-button / OK** to activate it, press  $\downarrow$  or  $\uparrow$  to navigate through the sub-menu functions. Once the desired sub-menu function is highlighted, press **MENU-button / OK** to activate it.
- 3). Press  $\downarrow$  or  $\uparrow$  to change the settings of the selected function. Press  $\leftarrow$  /  $\rightarrow$  to exit. If you want to adjust any other function, repeat steps 2-3.
- 4). OSD Lock Function: To lock the OSD, press and hold the **MENU-button** while the monitor is off and then press  $\text{power}$  button to turn the monitor on. To unlock the OSD - press and hold the **MENU-button** while the monitor is off and then press  $\text{power}$  button to turn the monitor on.

## Notes:

- 1). If the product has only one signal input, the item of "Input Select" is unable to be adjusted.
- 2). If the input signal resolution is the native resolution or Adaptive-Sync, then the item "Image Ratio" is invalid.



## Game Setting

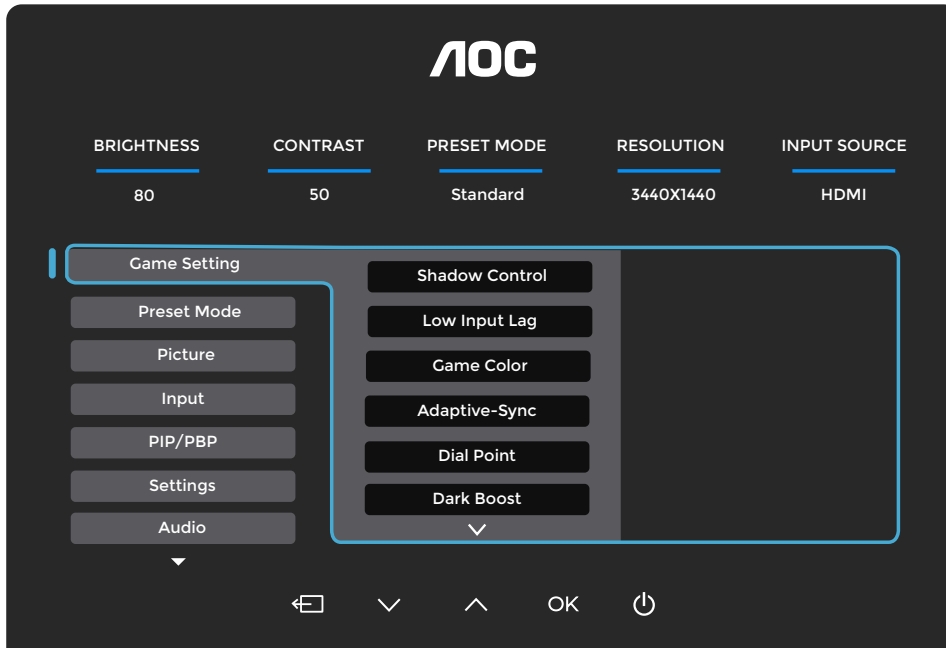

Shadow Control	0-20	Shadow Control Default is 0, then end-user can adjust from 0 to 20 increase for a clearer picture. If picture is too dark to be saw the detail clearly, adjusting from 0 to 20 for a clear picture.
Low Input Lag	Off / On	Turn off frame buffer to decrease input lag.
Game Color	0 ~ 20	Game Color will provide 0-20 level for adjusting saturation to get a better picture.
Adaptive-Sync	Off / On	Disable or Enable Adaptive-Sync. Adaptive-Sync Run Reminder: When the Adaptive-Sync feature is enabled, there may be flashing in some game environments.
Dial Point	Off / On / Dynamic	The "Dial Point" function places an aiming indicator in the center of screen for helping gamers to play First Person Shooter (FPS) games with accurate and precise aiming.
Dark Boost	Off / Level 1 / Level 2 / Level 3	Enhance the screen details in the dark or bright area to adjust the brightness in the bright area and ensure that it is not oversaturated.
MBR	0 ~ 20	MBR (Motion Blur Reduction) Provides 0-20 levels of adjustments to reduce motion blur. Note: 1. The MBR function can be adjusted when Adaptive-Sync is turned off, and the refresh rate $\geq 75\text{Hz}$ . 2. The brightness of the screen will decrease as the adjustment value increases.
MBR Sync	Off / On	Disable or Enable MBR Sync (Motion Blur Remove).
Overdrive	Off / Weak / Medium / Strong / Boost	Adjusts the monitor's response time. Notes: Setting OverDrive to Strong may cause image blurring. Adjust or disable OverDrive based on personal viewing preferences. Boost is available only when Adaptive-Sync is disabled and the refresh rate is 75Hz or higher. Activating Boost will reduce screen brightness.

### Preset Mode Limitations:

1).When using "Reading", "HDR Effect-Picture", "HDR Effect-Movie", "HDR Effect-Game", "Uniformity", "FPS", "RTS", and "Racing game modes", "Dark Boost", "Shadow Control", and "Game Color" will be disabled.In Reading and Uniformity modes, OD is not selectable.

2).When HDR is enabled, "Dark Boost", "Shadow Control", "Game Color", "MBR", "MBR Sync" cannot be adjusted."Boost" under "Overdrive" is not available.After Dark Boost is enabled, Shadow Control and Game Color will be grayed out and cannot be selected.

When the "Color Space" under "Picture" is set to sRGB, the items "Shadow Control", "Game Color", "MBR", "MBR Sync" and "Dark Boost" can not be adjusted. "Boost" under "Overdrive" is not available.

## Preset Mode

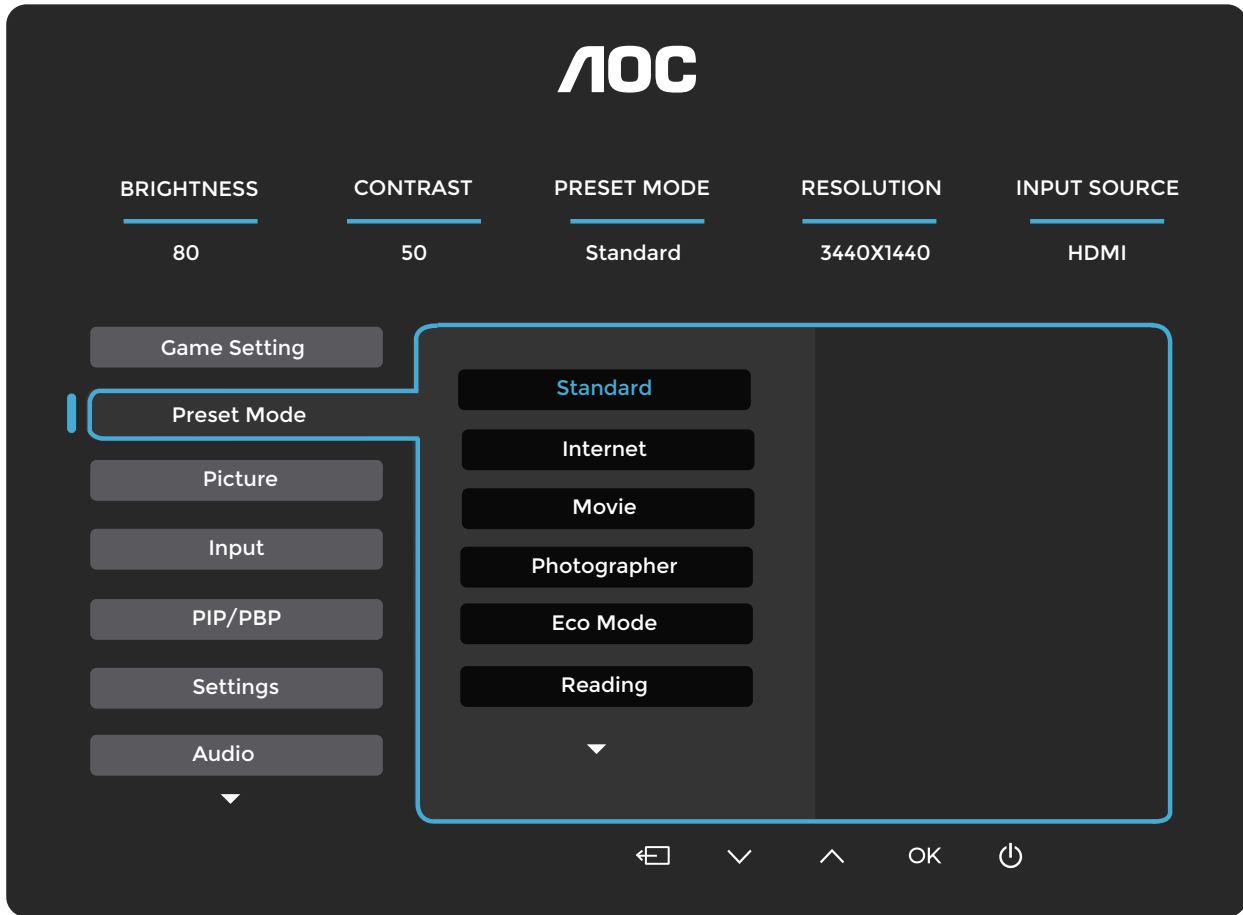

Standard		Enhance readability for suitable web and mobile games.
Internet		Internet Mode.
Movie		Movie Mode.
Photographer		Photographer Mode.
Eco Mode		Eco Mode
Reading		Reading Mode.
HDR Effect - Picture		Set the HDR Effect according to your usage requirements.
HDR Effect - Movie		
HDR Effect - Game		
Sports		Sports Mode.
Uniformity		Uniformity Mode
FPS		For playing FPS (First Person Shooters) games. Improves black level in dark theme.
RTS		For playing RTS (Real Time Strategy) games. Improves the image quality.
Racing		For playing Racing games, Provides fastest response time and high color saturation.
Reset Color	No / Yes	Reset the Color to default.

# Picture

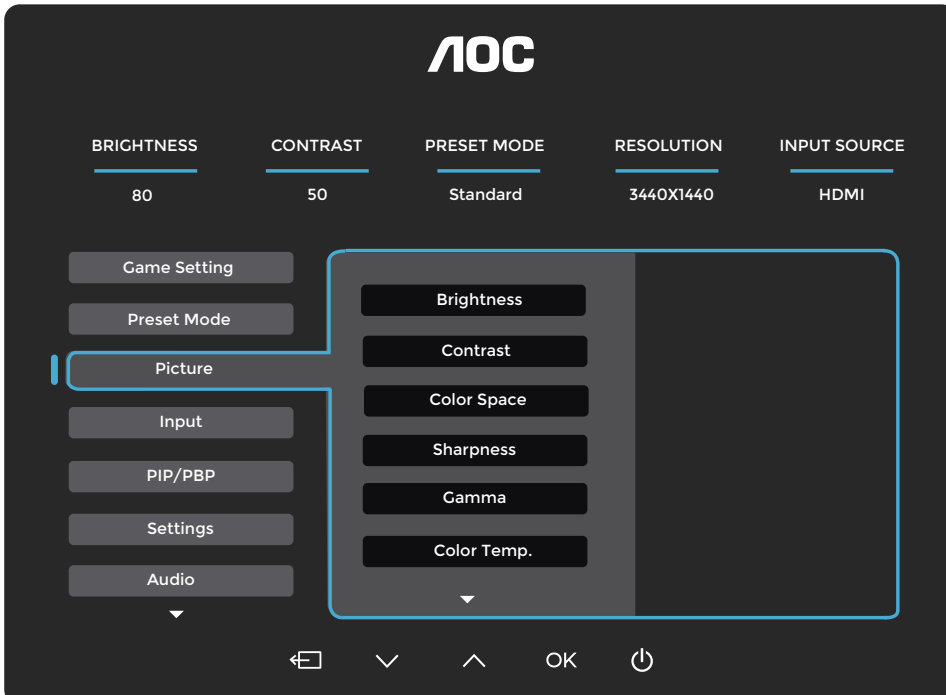

Brightness	0-100	Backlight Adjustment.
Contrast	0-100	Contrast from Digital-register.
Color Space	Panel Native	Standard color space panel.
	sRGB	sRGB Color space.
Sharpness	0-100	Sharpness Adjustment.
Gamma	1.8 / 2.0 / 2.2 / 2.4 / 2.6	Adjust Gamma.
Color Temp.	Native/5000K/ 6500K/7500K/ 8200K/9300K/ 11500K/User Define	Recall Color Temp. from EEPROM.
Red	0-100	Red gain from Digital-register.
Green	0-100	Green gain from Digital-register.
Blue	0-100	Blue gain from Digital-register.
DCR	Off / On	Disable /Disable dynamic contrast ratio.
Clear Vision	Off/Weak/Medium/ Strong	Adjust the Clear Vision
LowBlue Mode	Off	Decrease blue light wave by controlling color temperature.
	Multimedia	
	Internet	
	Office	
Image Ratio	Full/Aspect/1:1	Select image ratio for display.

**Note:**

- 1). When "Reading /HDR Effect – Picture/HDR Effect – Movie/HDR Effect – Game/Uniformity/FPS/RTS/Racing under "Preset Mode" is enable, the items "Contrast", "Color Space", "Gamma", cannot be adjusted. In Reading and Uniformity modes, Color Temp. is grayed out and cannot be selected. In Uniformity mode, Sharpness, DCR, Clear Vision, and Low Blue Mode are grayed out and cannot be selected.
- 2). When "HDR" is DisplayHDR, the items "Brightness", "Contrast", "Color Space", "Gamma", "Color Temp.", "Clear Vision", "DCR", "LowBlue Mode" cannot be adjusted.
- 3). When "HDR" is HDR Picture/Movie/Game, the items "Color Space", "Gamma", "Color Temp.", "DCR", "LowBlue Mode" cannot be adjusted.
- 4). When Clear Vision is enabled, Sharpness gray return cannot be selected

## Input



Auto	Select input signal source Automatically.
HDMI	Select HDMI input signal source.
DisplayPort	Select DisplayPort input signal source.

## PIP/PBP

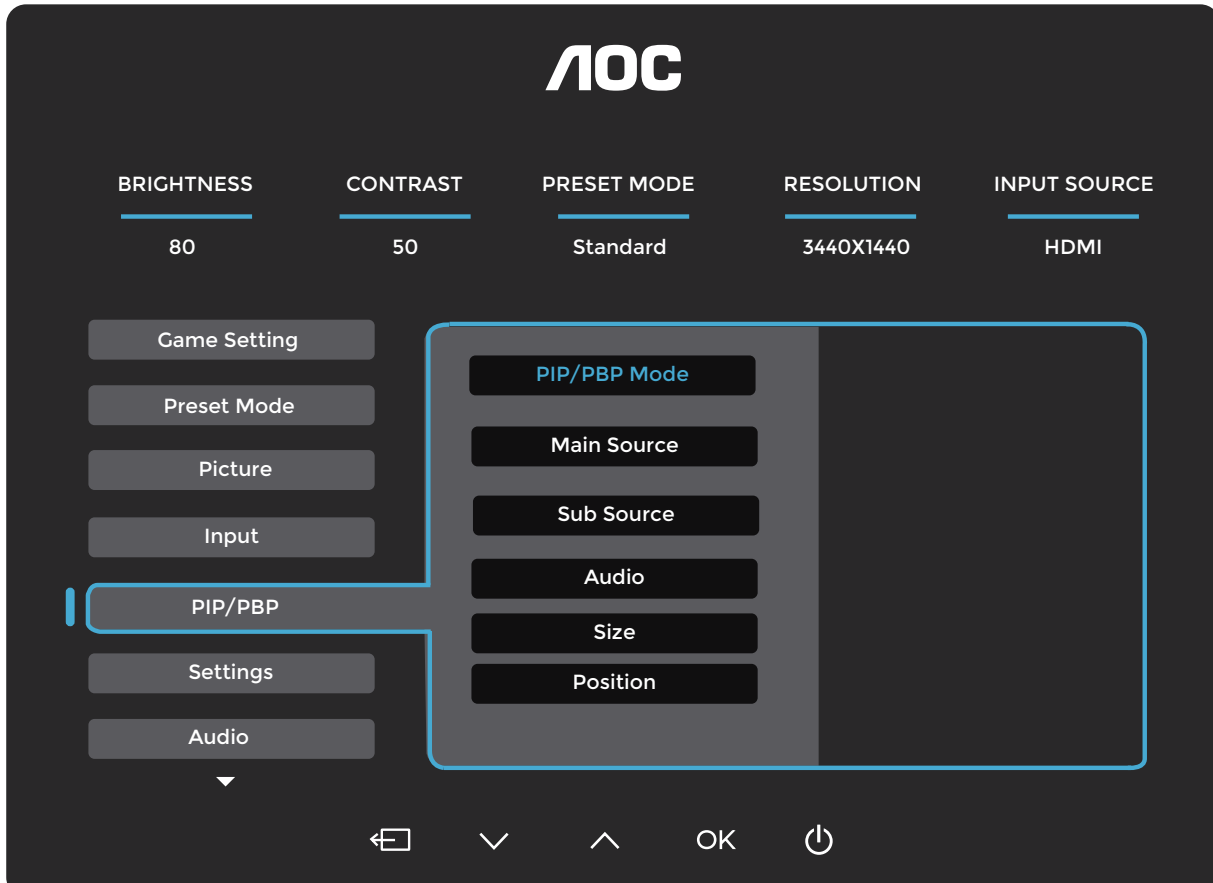

PIP/PBP Mode	Off / PIP / PBP	Disable or Enable PIP or PBP.
Main Source		Select main screen source.
Sub Source		Select sub screen source.
Audio	Main Source	Disable or Enable Audio Setup.
	Sub Source	
Size	Small / Middle / Large	Select screen size.
Position	Right-up	Set the screen location.
	Right-down	
	Left-up	
	Left-down	
Swap	On: Swap	Swap the screen source.
	Off: non action	

Note:

- 1). When "HDR" under "Picture" is set to non-off state, all items under "PIP/PBP" cannot be adjusted.

2) When PBP/PIP is enabled, the main screen/secondary screen input source compatibility is as follows:

PBP		Main source	
		HDMI	DisplayPort
Sub source	HDMI	V	V
	DisplayPort	V	V

PIP		Main source	
		HDMI	DisplayPort
Sub source	HDMI	V	V
	DisplayPort	V	V

- 2). When PIP/PBP is enabled, the maximum supported refresh rate is 60Hz.
- 3). When PxP = OFF, OD is selectable. When PxP = ON, OD is grayed out and cannot be selected, but OD cannot be forcibly set to OFF. At this time, after PxP is turned OFF, it needs to return to its original state.
- 4). PIP/PBP and Adaptive-Sync have an implicit conflict and cannot be enabled at the same time.

# Settings

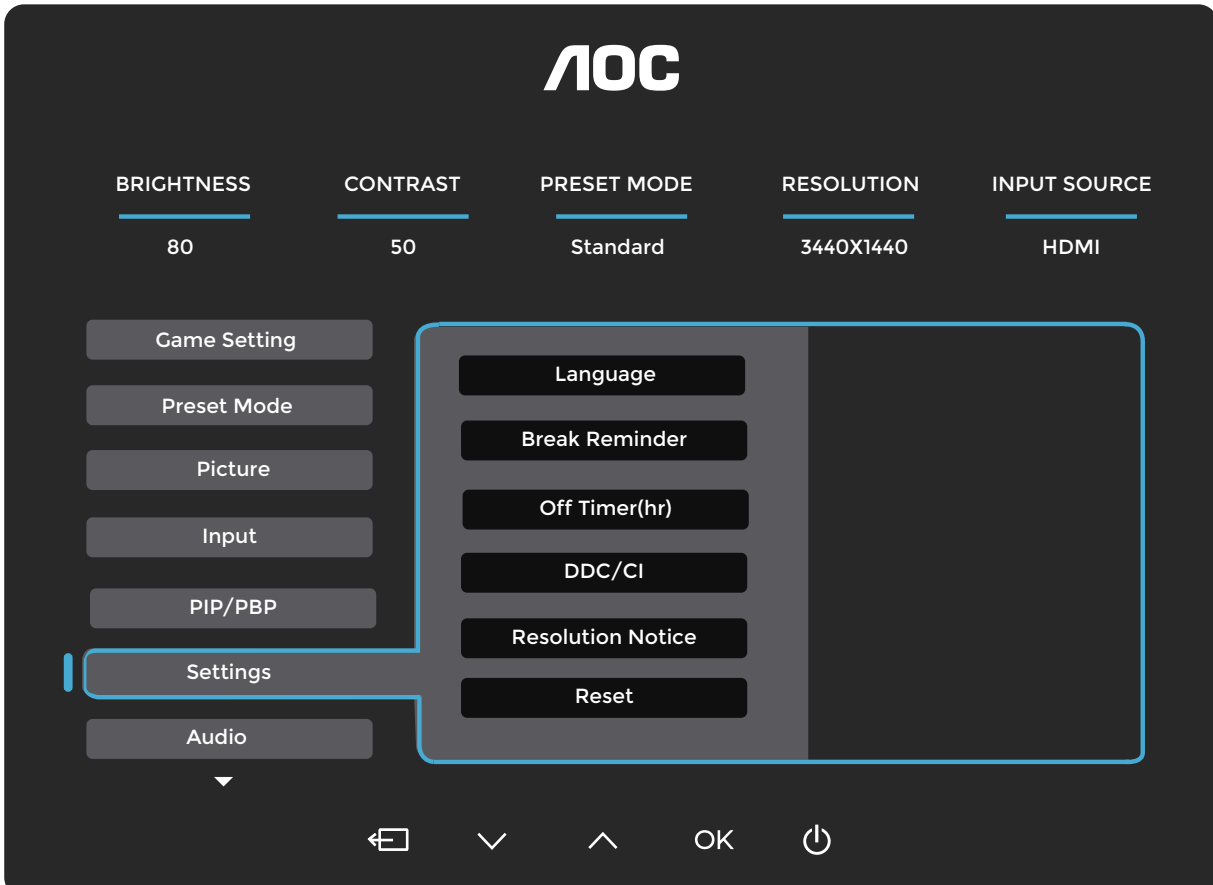

Language		Select the OSD language.
Break Reminder	Off / On	Break reminder if the user continuously works for more than 1hrs.
Off Timer(hr)	0-24	Select DC off time.
DDC/CI	No / Yes	Turn On/Off DDC/CI Support.
Resolution Notice	Off / On	Optimal resolution prompt.
Reset	No / Yes	Reset the menu to default.



## Audio

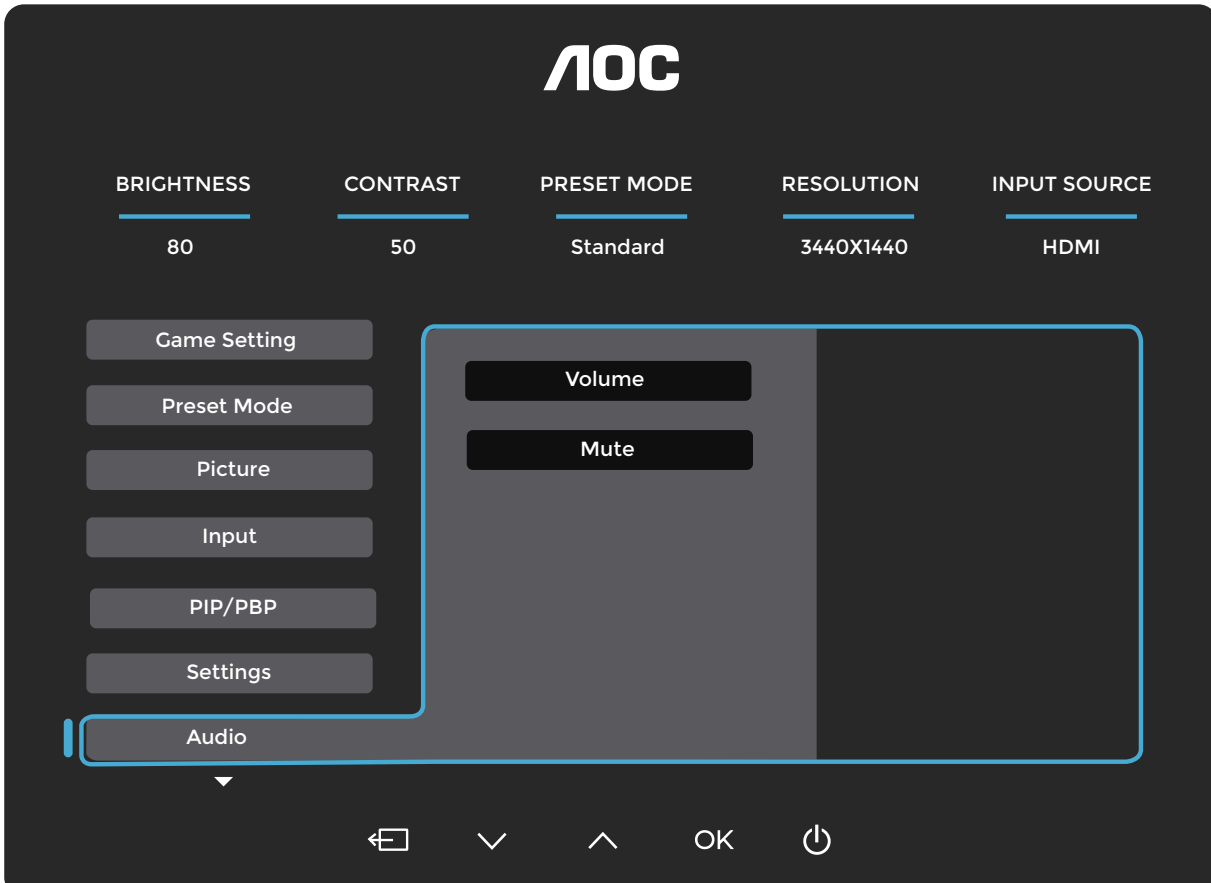

Volume	0-100	Volume Adjustment.
Mute	Off / On	Mute the volume.

## OSD Setup

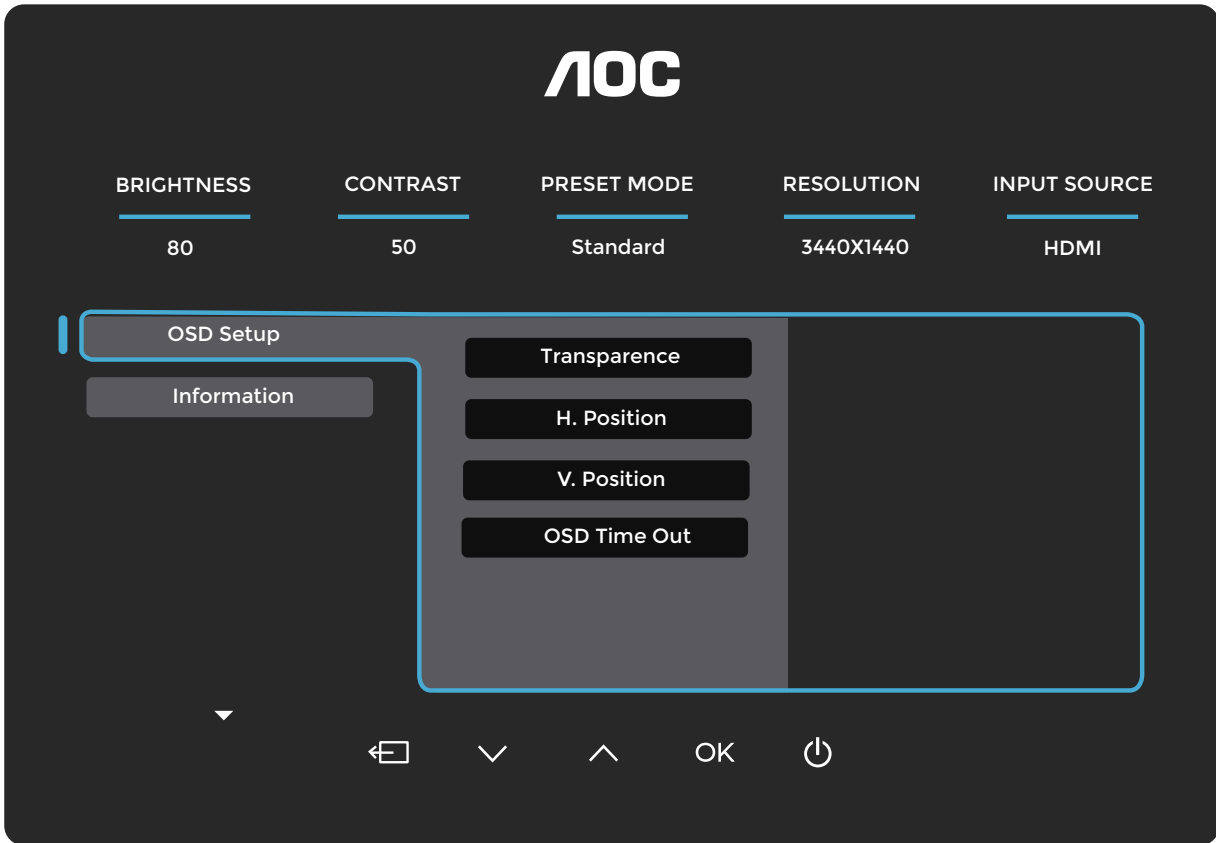

Transparence	0-100	Adjust the transparence of OSD.
H. Position	0-100	Adjust the horizontal position of OSD.
V. Position	0-100	Adjust the vertical position of OSD.
OSD Time Out	5-120	Adjust the OSD Timeout.

# Information



## LED Indicator

Status	LED Color
Full Power Mode	White
Active-off Mode	Orange

# Troubleshoot

Problem & Question	Possible Solutions
<b>Power LED Is Not ON</b>	Make sure the power button is ON and the Power Cord is properly connected to a grounded power outlet and to the monitor.
<b>No image on the screen</b>	<ul style="list-style-type: none"> <li>● Is the power cord connected properly? Check the power cord connection and power supply.</li> <li>● Is the video cable connected correctly? (Connected using the HDMI cable) Check the HDMI cable connection. (Connected using the DisplayPort cable) Check the DisplayPort cable connection. * HDMI/DisplayPort input is not available on every model.</li> <li>● If the power is on, reboot the computer to see the initial screen (the login screen.) If the initial screen (the login screen) appears, boot the computer in the applicable mode (the safe mode for Windows 7/8/10) and then change the frequency of the video card. (Refer to the Setting the Optimal Resolution) If the initial screen (the login screen) does not appear, contact the Service Center or your dealer.</li> <li>● Can you see "Input Not Supported" on the screen? You can see this message when the signal from the video card exceeds the maximum resolution and frequency that the monitor can handle properly. Adjust the maximum resolution and frequency that the monitor can handle properly.</li> <li>● Make sure the AOC Monitor Drivers are installed.</li> </ul>
<b>Picture Is Fuzzy &amp; Has Ghosting Shadowing Problem</b>	Adjust the Contrast and Brightness Controls. Press hot-key (AUTO) to auto-adjust. Make sure you are not using an extension cable or switch box. We recommend plugging the monitor directly to the video card output connector on the back.
<b>Picture Bounces, Flickers Or Wave Pattern Appears In The Picture</b>	Move electrical devices that may cause electrical interference as far away from the monitor as possible. Use the maximum refresh rate your monitor is capable of at the resolution you are using.
<b>Monitor Is Stuck In Active Off-Mode"</b>	The Computer Power Switch should be in the ON position. The Computer Video Card should be snugly fitted in its slot. Make sure the monitor's video cable is properly connected to the computer. Inspect the monitor's video cable and make sure no pin is bent. Make sure your computer is operational by hitting the CAPS LOCK key on the keyboard while observing the CAPS LOCK LED. The LED should either turn ON or OFF after hitting the CAPS LOCK key.
<b>Missing one of the primary colors (RED, GREEN, or BLUE)</b>	Inspect the monitor's video cable and make sure that no pin is damaged. Make sure the monitor's video cable is properly connected to the computer.
<b>Screen image is not centered or sized properly</b>	Adjust H-Position and V-Position or press hot-key (AUTO).
<b>Picture has color defects (white does not look white)</b>	Adjust RGB color or select desired color temperature.
<b>Horizontal or vertical disturbances on the screen</b>	Use Windows 7/8/10/11 shut-down mode to adjust CLOCK and FOCUS. Press hot-key (AUTO) to auto-adjust.
<b>Regulation &amp; Service</b>	Please refer to Regulation & Service Information which is in the CD manual or <a href="http://www.aoc.com">www.aoc.com</a> (to find the model you purchase in your country and to find Regulation & Service Information in Support page.

# Specification

## General Specification

Panel	Model name	CU34B3E		
	Driving system	TFT Color LCD		
	Viewable Image Size	86.4 cm diagonal		
	Pixel pitch	0.23175mm(H) x 0.23175mm(V)		
	Display Color	10bit(8+FRC)		
Others	Horizontal scan range	30k-190kHz		
	Horizontal scan Size(Maximum)	797.22mm		
	Vertical scan range	48-100Hz(HDMI)		
		48-120Hz(DisplayPort)		
	Vertical Scan Size(Maximum)	333.72mm		
	Optimal preset resolution	3440x1440@60Hz		
	Max resolution	3440x1440@100Hz(HDMI)		
		3440x1440@120Hz(DisplayPort)		
	Plug & Play	VESA DDC2B/CI		
	Power Source	100-240V~, 50/60Hz, 1.5A		
	Power Consumption	Typical(default brightness and contrast)	31W	
		Max. (brightness = 100, contrast =100)	≤53W	
		Standby Mode	≤0.3W	
	Heat Dissipation	Normal Operation	105.80BTU/hr (typ.)	
Sleep (Standby mode)		<1.02 BTU/hr		
Off mode		<1.02 BTU/hr		
Off mode(AC switch)		0 BTU/hr		
Physical Characteristics	Connector Type	HDMI/DisplayPort/Earphone out		
	Signal Cable Type	Detachable		
Environmental	Temperature	Operating	0°C~40°C	
		Non-Operating	-25°C~55°C	
	Humidity	Operating	10%~85% (Non-Condensing)	
		Non-Operating	5%~93% (Non-Condensing)	
	Altitude	Operating	0m~5000m (0ft~16404ft)	
		Non-Operating	0m~12192m (0ft~40000ft)	

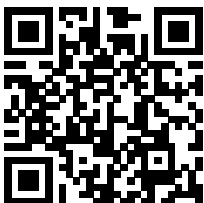

Note:

[1]The maximum number of display colors supported by this product is 1.07 billion, and the setting conditions are as follows (there may be differences due to the output limitation of some graphics cards)

("V":support, "\":nonsupport):

Signal Version Color Format State Color Bit	HDMI2.0		DisplayPort1.4	
	YCbCr420 YCbCr422	YCbCr444 RGB	YCbCr420 YCbCr422	YCbCr444 RGB
3440x1440 120Hz 10 bpc	\	\	V	V
3440x1440 120Hz 8 bpc	\	\	V	V
3440x1440 100Hz 10 bpc	V	\	V	V
3440x1440 100Hz 8 bpc	V	V	V	V
Low Resolution 10 bpc	V	V	V	V
Low Resolution 8 bpc	V	V	V	V

# AOC Monitors Panel Pixel Defect Policy

AOC strives to deliver the highest quality products. We use some of the industry's most advanced manufacturing processes and practice stringent quality control. However, pixel or sub pixel defects on the Monitor panels used in the monitors are sometimes unavoidable.

No manufacturer can guarantee that all panels will be free from pixel defects, but AOC guarantees that any monitor with an unacceptable number of defects will be repaired or replaced under warranty. This notice explains the different types of pixel defects and defines acceptable defect levels for each type. In order to qualify for repair or replacement under warranty, the number of pixel defects on a Monitor panel must exceed these acceptable levels. For example, no more than 0.0004% of the sub pixels on a monitor may be defective.

Furthermore, AOC sets even higher quality standards for certain types or combinations of pixel defects that are more noticeable than others. This policy is valid worldwide.

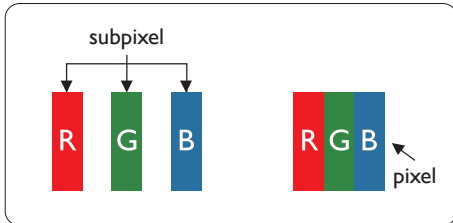

## Pixels and Sub pixels

A pixel, or picture element, is composed of three sub pixels in the primary colors of red, green and blue. Many pixels together form an image. When all sub pixels of a pixel are lit, the three colored sub pixels together appear as a single white pixel. When all are dark, the three colored sub pixels together appear as a single black pixel. Other combinations of lit and dark sub pixels appear as single pixels of other colors.

## Types of Pixel Defects

Pixel and sub pixel defects appear on the screen in different ways. There are two categories of pixel defects and several types of sub pixel defects within each category.

### Bright Dot Defects

Bright dot defects appear as pixels or sub pixels that are always lit or 'on'. That is, a bright dot is a sub-pixel that stands out on the screen when the monitor displays a dark pattern. There are the types of bright dot defects.

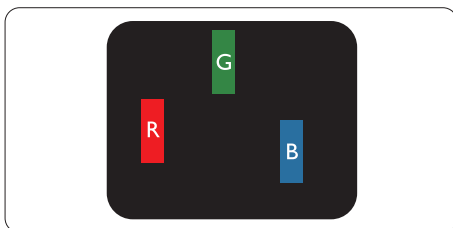

One lit red, green or blue sub pixel.

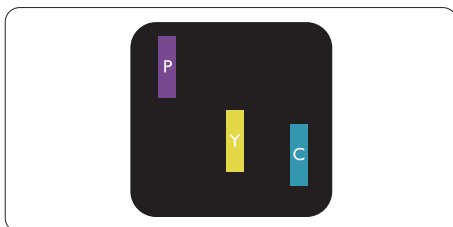

Two adjacent lit sub pixels:

- Red + Blue = Purple
- Red + Green = Yellow
- Green + Blue = Cyan (Light Blue)



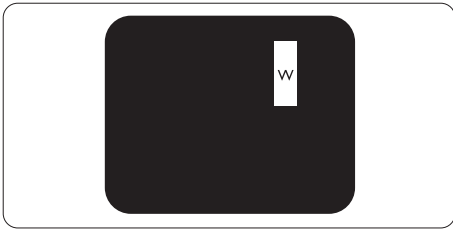

Three adjacent lit sub pixels (one white pixel).

Note

A red or blue bright dot must be more than 50 percent brighter than neighboring dots while a green bright dot is 30 percent brighter than neighboring dots.

### Black Dot Defects

Black dot defects appear as pixels or sub pixels that are always dark or 'off'. That is, a dark dot is a sub-pixel that stands out on the screen when the monitor displays a light pattern. These are the types of black dot defects.

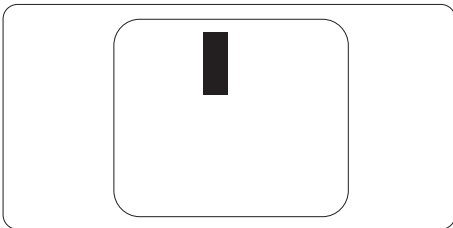

### Proximity of Pixel Defects

Because pixel and sub pixels defects of the same type that are near to one another may be more noticeable, AOC also specifies tolerances for the proximity of pixel defects.

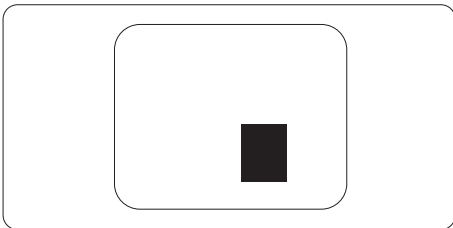

### Pixel Defect Tolerances

In order to qualify for repair or replacement due to pixel defects during the warranty period, a Monitor panel in a AOC panel monitor must have pixel or sub pixel defects exceeding the tolerances listed in the web manual.

<b>BRIGHT DOT DEFECTS</b>	<b>ACCEPTABLE LEVEL</b>
1 lit subpixel	2
2 adjacent lit subpixels	1
3 adjacent lit subpixels (one white pixel)	0
Distance between two bright dot defects*	$\geq 15\text{mm}$
Total bright dot defects of all types	2
<b>BLACK DOT DEFECTS</b>	<b>ACCEPTABLE LEVEL</b>
1 dark subpixel	5 or fewer
2 adjacent dark subpixels	2 or fewer
3 adjacent dark subpixels	$\leq 0$
Distance between two black dot defects*	$\geq 15\text{mm}$
Total black dot defects of all types	5 or fewer
<b>TOTAL DOT DEFECTS</b>	<b>ACCEPTABLE LEVEL</b>
Total bright or black dot defects of all types	5 or fewer

Note

\*: 1 or 2 adjacent sub pixel defects = 1 dot defect.

## Preset Display Modes

STANDARD	RESOLUTION( $\pm$ 1Hz)	HORIZONTAL FREQUENCY(KHz)	VERTICAL FREQUENCY(Hz)
VGA	640x480@60Hz	31.469	59.94
	640x480@67Hz	35	67
	640x480@72Hz	37.861	72.809
	640x480@75Hz	37.5	75
SVGA	800x600@56Hz	35.156	56.25
	800x600@60Hz	37.879	60.317
	800x600@72Hz	48.077	72.188
	800x600@75Hz	46.875	75
XGA	1024x768@60Hz	48.363	60.004
	1024x768@70Hz	56.476	70.069
	1024x768@75Hz	60.023	75.029
WXGA+	1440x900@60Hz	55.935	59.887
	832x624@75Hz	49.725	74.77
	1680x1050@60Hz	64.674	59.883
Full HD	1920x1080@60Hz	67.5	60
SXGA	1280x1024@60Hz	63.981	60.02
	1280x1024@75Hz	79.976	75.025
	1280x720@60Hz	44.772	59.855
	1280x960@60Hz	60	60
	2560x1080@60Hz	67.173	59.976
QHD	2560x1440@120Hz	176.4	120
WQHD	3440x1440@60Hz	88.861	60
	3440x1440@100Hz	149	100
	3440x1440@30Hz	44.43	30
	3440x1440@120Hz (DisplayPort)	176.4	120

Note: According to the VESA standard, there may be a certain error ( $\pm$ 1Hz) when calculating the refresh rate (field frequency) of different operating systems and graphics cards. In order to improve compatibility, the nominal refresh rate of this product has been rounded off. Please refer to the actual product.

## Pin Assignments



19-Pin Color Display Signal Cable

Pin No.	Signal Name	Pin No.	Signal Name	Pin No.	Signal Name
1.	TMDS Data 2+	9.	TMDS Data 0-	17.	DDC/CEC Ground
2.	TMDS Data 2 Shield	10.	TMDS Clock +	18.	+5V Power
3.	TMDS Data 2-	11.	TMDS Clock Shield	19.	Hot Plug Detect
4.	TMDS Data 1+	12.	TMDS Clock-		
5.	TMDS Data 1Shield	13.	CEC		
6.	TMDS Data 1-	14.	Reserved (N.C. on device)		
7.	TMDS Data 0+	15.	SCL		
8.	TMDS Data 0 Shield	16.	SDA		

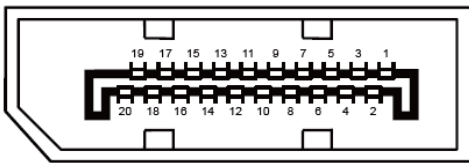

20-Pin Color Display Signal Cable

Pin No.	Signal Name	Pin No.	Signal Name
1	ML_Lane 3 (n)	11	GND
2	GND	12	ML_Lane 0 (p)
3	ML_Lane 3 (p)	13	CONFIG1
4	ML_Lane 2 (n)	14	CONFIG2
5	GND	15	AUX_CH(p)
6	ML_Lane 2 (p)	16	GND
7	ML_Lane 1 (n)	17	AUX_CH(n)
8	GND	18	Hot Plug Detect
9	ML_Lane 1 (p)	19	Return DP_PWR
10	ML_Lane 0 (n)	20	DP_PWR

# Plug and Play

## Plug & Play DDC2B Feature

This monitor is equipped with VESA DDC2B capabilities according to the VESA DDC STANDARD. It allows the monitor to inform the host system of its identity and, depending on the level of DDC used, communicate additional information about its display capabilities.

The DDC2B is a bi-directional data channel based on the I2C protocol. The host can request EDID information over the DDC2B channel.

