



CE EMC TEST REPORT

Applicant	:	TPV Electronics (Fujian) Co., Ltd.
Address	:	Rongqiao Economic and Technological Development Zone, Fuqing City, Fujian Province, P.R. China
Equipment under Test	:	LCD Monitor
Model No.	:	**32G4***** ("*" = 0-9, A-Z, a-z, +, -, /, \ or blank)
Report No.	:	DDT-B25080103-1E01
Issue Date	:	Sep. 16, 2025
Issued By	:	Tianjin Dongdian Testing Service Co., Ltd.
Address	:	Building D-1, No. 19, Weisi Road, Microelectronics Industrial Park, Development Area, Tianjin, China. Tel: +86-022-58038033, E-mail: rui.zhang@ap-sure.com, http://www.ddttest.com



REPORT

CONTENTS

1 Summary of Test Results	6
2 General Test Information	8
2.1 Description of EUT	8
2.2 Primary Function of EUT	8
2.3 Port of EUT	8
2.4 Accessories of EUT	9
2.5 Test peripherals	9
2.6 Block diagram EUT configuration for test	9
2.7 EUT operating mode(s)	10
2.8 Performance Criteria	10
2.9 Deviations of test standard	11
2.10 Test laboratory	11
2.11 Measurement uncertainty	11
2.12 Abbreviations	12
3 Conducted Emissions (AC mains power ports)	13
3.1 General Information	13
3.2 Test Equipment	13
3.3 Reference Standard	13
3.4 Test Arrangement	13
3.5 Test Specification and Limit	15
3.6 Test Result	15
4 Radiated Emissions (30MHz to 1GHz)	17
4.1 General Information	17
4.2 Test Equipment	17
4.3 Reference Standard	17
4.4 Test Arrangement	18
4.5 Test Specification and Limit	20
4.6 Test Result	20
5 Radiated Emissions (Above 1GHz)	22
5.1 General Information	22
5.2 Test Equipment	22
5.3 Reference Standard	22
5.4 Test Arrangement	23
5.5 Test Specification and Limit	25
5.6 Test Result	25
6 Harmonic Current Emissions	27
6.1 General Information	27
6.2 Test Equipment	27
6.3 Reference Standard	27
6.4 Test Arrangement	27
6.5 Test Specification and Limit	28
6.6 Test Result	28
7 Voltage Changes, Voltage Fluctuations and Flicker	30
7.1 General Information	30
7.2 Test Equipment	30
7.3 Reference Standard	30
7.4 Test Arrangement	30
7.5 Test Specification and Limit	31
7.6 Test Result	31
8 Electrostatic Discharge Immunity	32
8.1 General Information	32
8.2 Test Equipment	32
8.3 Reference Standard	32
8.4 Test Arrangement	32
8.5 Test Specification and Limit	33
8.6 Test Result	33

9 Radiated, Radio-frequency, Electromagnetic Field Immunity.....	35
9.1 General Information	35
9.2 Test Equipment.....	35
9.3 Reference Standard.....	35
9.4 Test Arrangement	36
9.5 Test Specification and Limit.....	36
9.6 Test Result.....	37
10 Electrical Fast Transient/Burst Immunity	38
10.1 General Information	38
10.2 Test Equipment.....	38
10.3 Reference Standard.....	38
10.4 Test Arrangement	38
10.5 Test Specification and Limit.....	39
10.6 Test Result.....	40
11 Surge Immunity	41
11.1 General Information	41
11.2 Test Equipment.....	41
11.3 Reference Standard.....	41
11.4 Test Arrangement	41
11.5 Test Specification and Limit.....	42
11.6 Test Result.....	43
12 Immunity to Conducted Disturbances, Induced by Radio-frequency Fields	44
12.1 General Information	44
12.2 Test Equipment.....	44
12.3 Reference Standard.....	44
12.4 Test Arrangement	45
12.5 Test Specification and Limit.....	46
12.6 Test Result.....	46
13 Power Frequency Magnetic Field Immunity	47
13.1 General Information	47
13.2 Test Equipment.....	47
13.3 Reference Standard.....	47
13.4 Test Arrangement	47
13.5 Test Specification and Limit.....	48
13.6 Test Result.....	48
14 Voltage Dips, Short Interruptions and Voltage Variations Immunity.....	49
14.1 General Information	49
14.2 Test Equipment.....	49
14.3 Reference Standard.....	49
14.4 Test Arrangement	49
14.5 Test Specification and Limit.....	50
14.6 Test Result.....	50
Annex A. Test Setup Photos	51

Test Report Declare

Applicant	:	TPV Electronics (Fujian) Co., Ltd.
Address	:	Rongqiao Economic and Technological Development Zone, Fuqing City, Fujian Province, P.R. China
Equipment under Test	:	LCD Monitor
Model No.	:	**32G4***** ("*" = 0-9, A-Z, a-z, +, -, /, \ or blank)

Test Standard Used:

EN 55032:2015,EN 55032:2015/A11:2020,EN 55032:2015/A1:2020,BS EN 55032:2015+A1:2020,BS EN 55032:2015,BS EN 55032:2015+A11:2020,CISPR 32:2015,CISPR 32:2015/AMD1:2019,AS/NZS CISPR 32:2015,AS/NZS CISPR 32:2015 AMD 1:2020,EN 61000-3-2:2014,EN IEC 61000-3-2:2019/A1:2021,EN IEC 61000-3-2:2019/A2:2024,EN IEC 61000-3-2:2019,BS EN IEC 61000-3-2:2019+A1:2021,BS EN IEC 61000-3-2:2019+A2:2024,EN 61000-3-3:2013,EN 61000-3-3:2013/A1:2019,EN 61000-3-3:2013/A2:2021,EN 61000-3-3:2013/A2:2021/AC:2022-01,BS EN 61000-3-3:2013,BS EN 61000-3-3:2013+A1:2019,BS EN 61000-3-3:2013+A2:2021,EN 55035:2017,EN 55035:2017/A11:2020,BS EN 55035:2017+A11:2020,CISPR 35:2016,IEC 61000-4-2:2025,IEC 61000-4-3:2020,IEC 61000-4-4:2012,IEC 61000-4-5:2014+AMD1:2017 CSV,IEC 61000-4-6:2023,IEC 61000-4-8:2009,IEC 61000-4-11:2020/COR2:2022

We Declare:

The equipment described above is tested and assessed by Tianjin Dongdian Testing Service Co., Ltd. and in the configuration assessed the equipment complied with the standards specified above. The tested and assessed results are contained in this test report and Tianjin Dongdian Testing Service Co., Ltd. is assumed of full responsibility for the accuracy and completeness of these assessments.

After test and evaluation, our opinion is that the equipment provided test compliance with the requirement of the above standards.

Report No.:	DDT-B25080103-1E01		
Date of Receipt:	Aug. 11, 2025	Date of Test:	Aug. 13, 2025~Sep. 01, 2025



Prepared By:

Novak Wei

Novak Wei/Engineer

Approved By:

Aaron Zhang

Aaron Zhang/EMC Manager

Note: This report applies to above tested sample only. This report shall not be reproduced in parts without written approval of Tianjin Dongdian Testing Service Co., Ltd. The report must not be used by the client to claim product certification, approval, or endorsement by NVLAP, NIST, or any agency of the U.S. Government.

Revision History

Rev	Revisions	Issue Date	Revised By
---	Initial issue	Sep. 16, 2025	

1 Summary of Test Results

Description of Test Item	Standard	Result
Conducted Emissions (AC mains power ports)	EN 55032:2015, EN 55032:2015/A11:2020, EN 55032:2015/A1:2020, BS EN 55032:2015+A1:2020, BS EN 55032:2015, BS EN 55032:2015+A11:2020, CISPR 32:2015, CISPR 32:2015/AMD1:2019, AS/NZS CISPR 32:2015, AS/NZS CISPR 32:2015 AMD 1:2020	Pass
Radiated Emissions (30MHz to 1GHz)	EN 55032:2015, EN 55032:2015/A11:2020, EN 55032:2015/A1:2020, BS EN 55032:2015+A1:2020, BS EN 55032:2015, BS EN 55032:2015+A11:2020, CISPR 32:2015, CISPR 32:2015/AMD1:2019, AS/NZS CISPR 32:2015, AS/NZS CISPR 32:2015 AMD 1:2020	Pass
Radiated Emissions (Above 1GHz)	EN 55032:2015, EN 55032:2015/A11:2020, EN 55032:2015/A1:2020, BS EN 55032:2015+A1:2020, BS EN 55032:2015, BS EN 55032:2015+A11:2020, CISPR 32:2015, CISPR 32:2015/AMD1:2019, AS/NZS CISPR 32:2015, AS/NZS CISPR 32:2015 AMD 1:2020	Pass
Harmonic Current Emissions	EN 61000-3-2:2014, EN IEC 61000-3-2:2019/A1:2021, EN IEC 61000-3-2:2019/A2:2024, EN IEC 61000-3-2:2019, BS EN IEC 61000-3-2:2019+A1:2021, BS EN IEC 61000-3-2:2019+A2:2024,	Pass
Voltage Changes, Voltage Fluctuations and Flicker	EN 61000-3-3:2013, EN 61000-3-3:2013/A1:2019, EN 61000-3-3:2013/A2:2021, EN 61000-3-3:2013/A2:2021/AC:2022-01, BS EN 61000-3-3:2013, BS EN 61000-3-3:2013+A1:2019, BS EN 61000-3-3:2013+A2:2021,	Pass
Electrostatic Discharge Immunity	EN 55035:2017, EN 55035:2017/A11:2020, BS EN 55035:2017+A11:2020, CISPR 35:2016, IEC 61000-4-2:2025	Pass
Radiated, Radio-frequency, Electromagnetic Field Immunity	EN 55035:2017, EN 55035:2017/A11:2020, BS EN 55035:2017+A11:2020, CISPR 35:2016, IEC 61000-4-3:2020	Pass

Electrical Fast Transient/Burst Immunity	EN 55035:2017, EN 55035:2017/A11:2020, BS EN 55035:2017+A11:2020, CISPR 35:2016, IEC 61000-4-4:2012	Pass
Surge Immunity	EN 55035:2017, EN 55035:2017/A11:2020, BS EN 55035:2017+A11:2020, CISPR 35:2016, IEC 61000-4-5:2014+AMD1:2017 CSV	Pass
Immunity to Conducted Disturbances, Induced by Radio-frequency Fields	EN 55035:2017, EN 55035:2017/A11:2020, BS EN 55035:2017+A11:2020, CISPR 35:2016, IEC 61000-4-6:2023	Pass
Power Frequency Magnetic Field Immunity	EN 55035:2017, EN 55035:2017/A11:2020, BS EN 55035:2017+A11:2020, CISPR 35:2016, IEC 61000-4-8:2009	Pass
Voltage Dips, Short Interruptions and Voltage Variations Immunity	EN 55035:2017, EN 55035:2017/A11:2020, BS EN 55035:2017+A11:2020, CISPR 35:2016, IEC 61000-4-11:2020/COR2:2022	Pass

2 General Test Information

2.1 Description of EUT

EUT Name	: LCD Monitor
Model Number	: **32G4***** ("*" = 0-9, A-Z, a-z, +, -, /, \ or blank)
Model Differences	: All models difference is in sale marketing.
Serial Number	: N/A
Test Model	: U32G4U
Sample No.	: Y25080103-01
Power supply	: AC 100-240V ~ 50/60Hz
Test Power supply	: AC 230V 50Hz, 110V 60Hz
EUT Class	: Class B
Maximum work frequency	: 1188 MHz

2.2 Primary Function of EUT

Function	Description
Broadcast reception function	N/A
Print	N/A
Scan	N/A
Display or display output	Display
Musical tone generating	N/A
Networking	N/A
Audio output	Audio output function (audio output port)
Telephony	N/A
Bluetooth	N/A
Other	N/A

2.3 Port of EUT

Port	Description
AC mains power ports	AC mains power port
DC network power port	N/A
Wired network port	N/A
Signal data/control port	Two HDMI in Ports, One DP in Port, Four USB-A Ports, One USB-B Port
Antenna port	N/A
Broadcast receiver tuner port	N/A
Audio output port	One Audio out Port
Video output port	N/A
Other	N/A

2.4 Accessories of EUT

Accessories	Manufacturer	Model No.	Description	Remark
AC Cable	N/A	N/A	Length: 1.2m/1.5m/1.8m, Unshielded	N/A
DP Cable	N/A	N/A	Length: 1.2m/1.5m/1.8m, Shielded	N/A
HDMI Cable	N/A	N/A	Length: 1.2m/1.5m/1.8m, Shielded	N/A
USB-A to USB-B Cable	N/A	N/A	Length: 1.2m/1.5m/1.8m, Shielded	N/A

2.5 Test peripherals

Device	Manufacturer	Model No.	Description	Remark
DVD	PHILIPS	TAEP200/93	HCPE2025000750	N/A
Hard Disk	TOSHIBA	DTB410	2157T08BTL SH	N/A
Headphone	N/A	N/A	N/A	N/A
Keyboard	DELL	N/A	N/A	N/A
Mouse	DELL	N/A	N/A	N/A
PC	Hewlett-Packard	TPC-W058-MT	8CG0321Q58	N/A
PC	LENOVO	GeekPro-14ACN	M70Q5KC0	N/A
PC	DELL	Vostro 5890	700SBD3	N/A
Speaker	JBL	JBL GO VM	ND0035-AI6859585	N/A
Speaker	JBL	GO2+	N/A	N/A
USB Memory	N/A	N/A	N/A	N/A

2.6 Block diagram EUT configuration for test

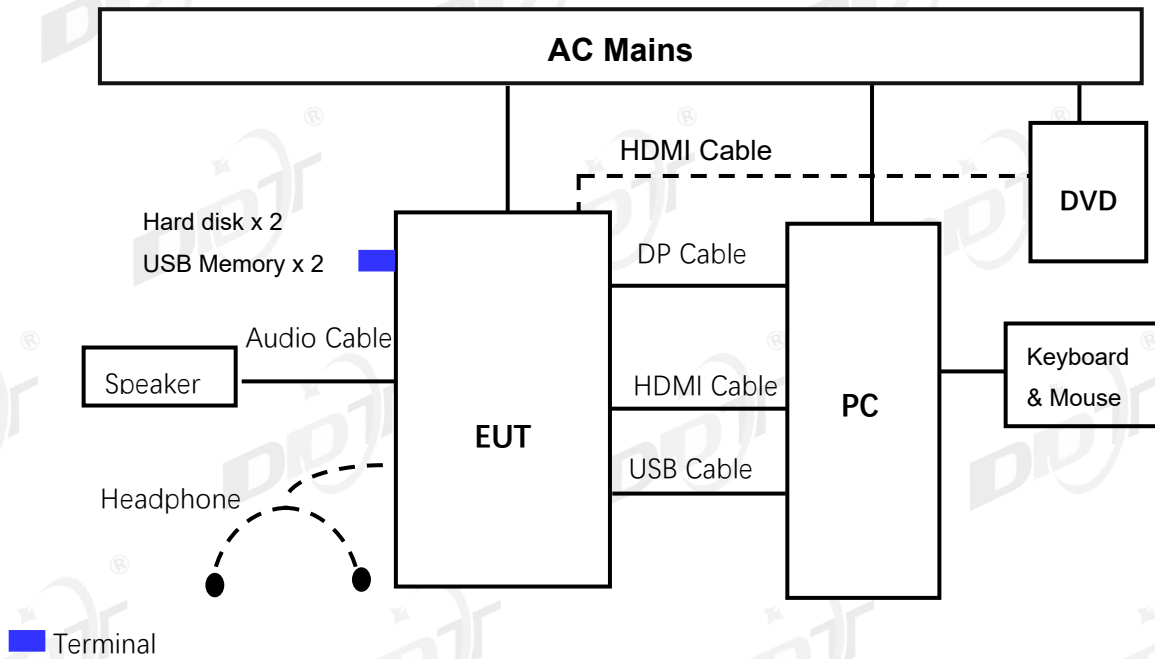

2.7 EUT operating mode(s)

Mode 1 HDMI1	Connect HDMI cable from PC's HDMI port to EUT's HDMI Port. Connect DP cable from PC's DP port to EUT's DP Port. Connect hard disk and USB memory to EUT's USB-A port. Switch source to HDMI1. The test signal is color bars with moving picture element according to ITU-R BT 471-1.
Mode 2 HDMI2	Connect HDMI cable from PC's HDMI port to EUT's HDMI Port. Connect DP cable from PC's DP port to EUT's DP Port. Connect hard disk and USB memory to EUT's USB-A port. Switch source to HDMI2. The test signal is color bars with moving picture element according to ITU-R BT 471-1.
Mode 3 DP	Connect HDMI cable from PC's HDMI port to EUT's HDMI Port. Connect DP cable from PC's DP port to EUT's DP Port. Connect hard disk and USB memory to EUT's USB-A port. Switch source to DP. The test signal is color bars with moving picture element according to ITU-R BT 471-1.

2.8 Performance Criteria

Criterion	Description
A	The equipment shall continue to operate as intended without operator intervention. No degradation of performance, loss of function or change of operating state is allowed below a performance level specified by the manufacturer when the equipment is used as intended. The performance level may be replaced by a permissible loss of performance. If the minimum performance level or the permissible performance loss is not specified by the manufacturer, then either of these may be derived from the product description and documentation, and by what the user may reasonably expect from the equipment if used as intended.
B	During the application of the disturbance, degradation of performance is allowed. However, no unintended change of actual operating state or stored data is allowed to persist after the test. After the test, the equipment shall continue to operate as intended without operator intervention; no degradation of performance or loss of function is allowed, below a performance level specified by the manufacturer, when the equipment is used as intended. The performance level may be replaced by a permissible loss of performance. If the minimum performance level (or the permissible performance loss), or recovery time, is not specified by the manufacturer, then either of these may be derived from the product description and documentation, and by what the user may reasonably expect from the equipment if used as intended.
C	Loss of function is allowed, provided the function is self-recoverable, or can be restored by the operation of the controls by the user in accordance with the manufacturer's instructions. A reboot or re-start operation is allowed. Information stored in non-volatile memory, or protected by a battery backup, shall not be lost.

2.9 Deviations of test standard

[Standard deviation 1] Electrostatic discharge immunity test was done according to IEC 61000-4-2:2025 instead of IEC 61000-4-2:2008.

[Standard deviation 2] Radiated, radio-frequency, electromagnetic field immunity test was done according to IEC 61000-4-3:2020 instead of IEC 61000-4-3:2006+AMD1:2007+AMD2:2010.

[Standard deviation 3] Surge immunity test was done according to IEC 61000-4-5:2014+AMD1:2017 CSV instead of IEC 61000-4-5:2005.

[Standard deviation 4] Radio-frequency conducted immunity test was done according to IEC 61000-4-6:2023 instead of IEC 61000-4-6:2008.

[Standard deviation 5] Voltage dips, short interruptions and voltage variations immunity tests was done according to IEC 61000-4-11:2020/COR2:2022 instead of IEC 61000-4-11:2004.

2.10 Test laboratory

Tianjin Dongdian Testing Service Co., Ltd.

Address: Building D-1, No. 19, Weisi Road, Microelectronics Industrial Park Development Area, Tianjin, China.

Tel: +86-22-58038033, <http://www.ddttest.com>, Email: ddt@dgddt.com

NVLAP (National Voluntary Laboratory Accreditation Program) CODE: 500036-0

CNAS (China National Accreditation Service for Conformity Assessment) CODE: L13402

FCC Designation Number: CN5004; FCC Test Firm Registration Number: 368676

ISED (Innovation, Science and Economic Development Canada) Company Number: 27768

Conformity Assessment Body Identifier: CN0125

VCCI Facility Registration Number: C-20089, T-20093, R-20125, G-20122

2.11 Measurement uncertainty

Test Item	Uncertainty
Conducted Emissions at Mains Power Port	3.4 dB (150KHz-30MHz)
Conducted Emissions at Telecommunication Port (ISN T800)	4.59 dB
Conducted Emissions at Telecommunication Port (ISN ST08)	3.5 dB
Radiated Emissions (30MHz to 1GHz)	5.2 dB (Antenna Polarize: Hor.)
	5.2 dB (Antenna Polarize: Ver.)
Radiated Emissions (Above 1GHz)	5.0 dB
Harmonic Current Emissions	3.1 %
Voltage Changes, Voltage Fluctuations and Flicker	1.7 %

Note: This uncertainty represents an expanded uncertainty expressed at approximately the 95% confidence level using a coverage factor of k=2.
We have conducted the Electrostatic discharge, Electrical fast transient/burst, Surge, Voltage dips, short interruptions and voltage variations tests to check the uncertainty. Radiated, radio-frequency, electromagnetic field 5.4 dB. Conducted disturbances, induced by radio-frequency fields 1.1 dB.

2.12 Abbreviations

For the purposes of the present document, the following abbreviations apply:

EUT: Equipment Under Test

QP: Quasi-Peak

PK: Peak,

AV: Average

CAV: CISPR Average

CDN: Coupling Decoupling Network

AM: Amplitude Modulation

N/A: Not Applicable

3 Conducted Emissions (AC mains power ports)

3.1 General Information

Test date	Aug. 13, 2025	Test engineer	Freya Wei	
Climate condition	Ambient temperature	23.3°C	Relative humidity	57.4%
	Atmospheric pressure	101.0kPa		
Test place	Shield Room 2#			

3.2 Test Equipment

Equipment	Manufacturer	Model No.	Serial No.	Last Cal.	Cal. Interval
Two-Line V-Network	Rohde & Schwarz	ENV216	101122	Feb. 17, 2025	1 Year
Two-Line V-Network	Rohde & Schwarz	ENV216	101254	Feb. 17, 2025	1 Year
EMI Test Receiver	Rohde & Schwarz	ESCI	100375	Feb. 17, 2025	1 Year
Test Software	TOYO	EP5/CE	Ver 5.4.40	N/A	N/A

3.3 Reference Standard

EN 55032:2015,
 EN 55032:2015/A11:2020,
 EN 55032:2015/A1:2020,
 BS EN 55032:2015+A1:2020,
 BS EN 55032:2015,
 BS EN 55032:2015+A11:2020,
 CISPR 32:2015,
 CISPR 32:2015/AMD1:2019,
 AS/NZS CISPR 32:2015,
 AS/NZS CISPR 32:2015 AMD 1:2020

3.4 Test Arrangement

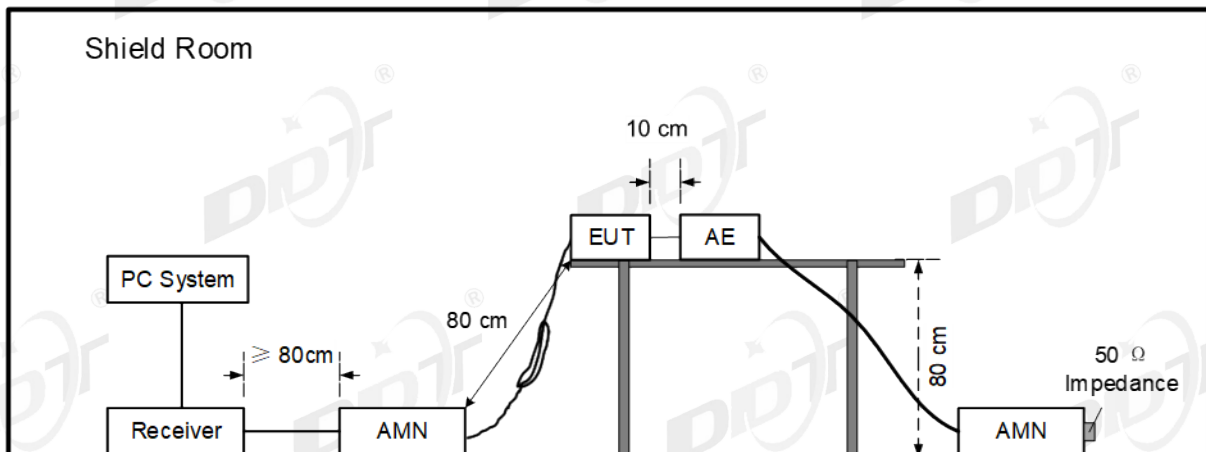

The EUT was placed on a non-metallic table, 80cm above the ground plane. The EUT's power adapter was connected to the power mains through a line impedance stabilization network (AMN), which provided a 50-ohm coupling impedance for the EUT (Please refer to the block diagram of the test setup and photographs). Both sides of power line

were checked for maximum conducted disturbance.

The bandwidth of test receiver is set at 9 kHz.

The frequency range from 150 kHz to 30MHz is checked.

Pre-scan measurements were performed in all operating mode or resolution. But final measurements were performed in worst cases based on pre-scan measurements.

The EUT with following test modes were pre-tested:

No.	Test Voltage	Operation Mode	Cable Length	Resolution	Rotation	Stand Position	Audio
1.	230V 50Hz	Mode1 HDMI 1	1.8m	3840*2160@120Hz	Landscape	HAS Stand-up	External Speaker
2.			1.8m	1920*1080@320Hz	Landscape	HAS Stand-up	External Speaker
3.			1.8m	800*600@60Hz	Landscape	HAS Stand-up	External Speaker
4.			1.5m	1920*1080@320Hz	Landscape	HAS Stand-up	External Speaker
5.			1.2m	1920*1080@320Hz	Landscape	HAS Stand-up	External Speaker
6.			1.8m	DVD	Landscape	HAS Stand-up	External Speaker
7.		Mode2 HDMI 2	1.8m	3840*2160@120Hz	Landscape	HAS Stand-up	External Speaker
8.			1.8m	1920*1080@320Hz	Landscape	HAS Stand-up	External Speaker
9.			1.8m	800*600@60Hz	Landscape	HAS Stand-up	External Speaker
10.			1.5m	1920*1080@320Hz	Landscape	HAS Stand-up	External Speaker
11.			1.2m	1920*1080@320Hz	Landscape	HAS Stand-up	External Speaker
12.			1.8m	DVD	Landscape	HAS Stand-up	External Speaker
13.		Mode3 DP	1.8m	3840*2160@160Hz	Landscape	HAS Stand-up	External Speaker
14.			1.8m	1920*1080@60Hz	Landscape	HAS Stand-up	External Speaker
15.			1.8m	800*600@60Hz	Landscape	HAS Stand-up	External Speaker
16.			1.5m	3840*2160@160Hz	Landscape	HAS Stand-up	External Speaker
17.			1.2m	3840*2160@160Hz	Landscape	HAS Stand-up	External Speaker
18.			The worst case above with 1.5m power cord		Landscape	HAS Stand-up	External Speaker
19.			The worst case above with 1.2m power cord		Landscape	HAS Stand-up	External Speaker
20.			The worst case above with 1.8m power cord		Portrait (-90 degree)	HAS Stand-up	External Speaker
21.			The worst case above with 1.8m power cord		Portrait (-270 degree)	HAS Stand-up	External Speaker
22.			The worst case above with 1.8m power cord		Landscape	HAS Stand- down	External Speaker
23.			The worst case above with 1.8m power cord with scrolling "H" pattern		Landscape	HAS Stand-up	External Speaker
24.			The worst case 1920*1080@60Hz with 1.8m power cord		Landscape	HAS Stand-up	Without Headphone
25.			The worst case 1920*1080@60Hz with 1.8m power cord		Landscape	HAS Stand-up	With Headphone

26.	110V 60Hz	The worst case above with 1.8m power cord	Landscape	HAS Stand-up	External Speaker
-----	--------------	---	-----------	-----------------	---------------------

3.5 Test Specification and Limit

Class B

Frequency	Quasi-Peak Level dB(μ V)	Average Level dB(μ V)
150kHz ~ 500kHz	66 ~ 56*	56 ~ 46*
500kHz ~ 5MHz	56	46
5MHz ~ 30MHz	60	50

Notes: 1. * Decreasing linearly with logarithm of frequency.

2. The lower limit shall apply at the transition frequencies.

Note for test result

Note1): According pre-test, the worst test modes decided as below and reported. Only data of worst mode was reported in test result.

Note2) Line = Polarity of input power (Live or Neutral), N: Abbreviation of Neutral Polarity, L1: Abbreviation of Live Polarity,

Note3) Level (Quasi-Peak and/or C/Average) = Meter Reading + Factor,

Note4) Factor = AMN (or AAN) Insertion Loss + Cable Loss,

Note5) Margin = Limit – Level (Quasi-Peak and/or C/Average)

3.6 Test Result

Sample No.	Operation Mode	Remarks	Result
Y25080103-01	Mode 1 HDMI1	Pre-scan measurement	Pass
Y25080103-01	Mode 2 HDMI2	Pre-scan measurement	Pass
Y25080103-01	Mode 3 DP	Final measurement, minimum margin 6.6 dB	Pass

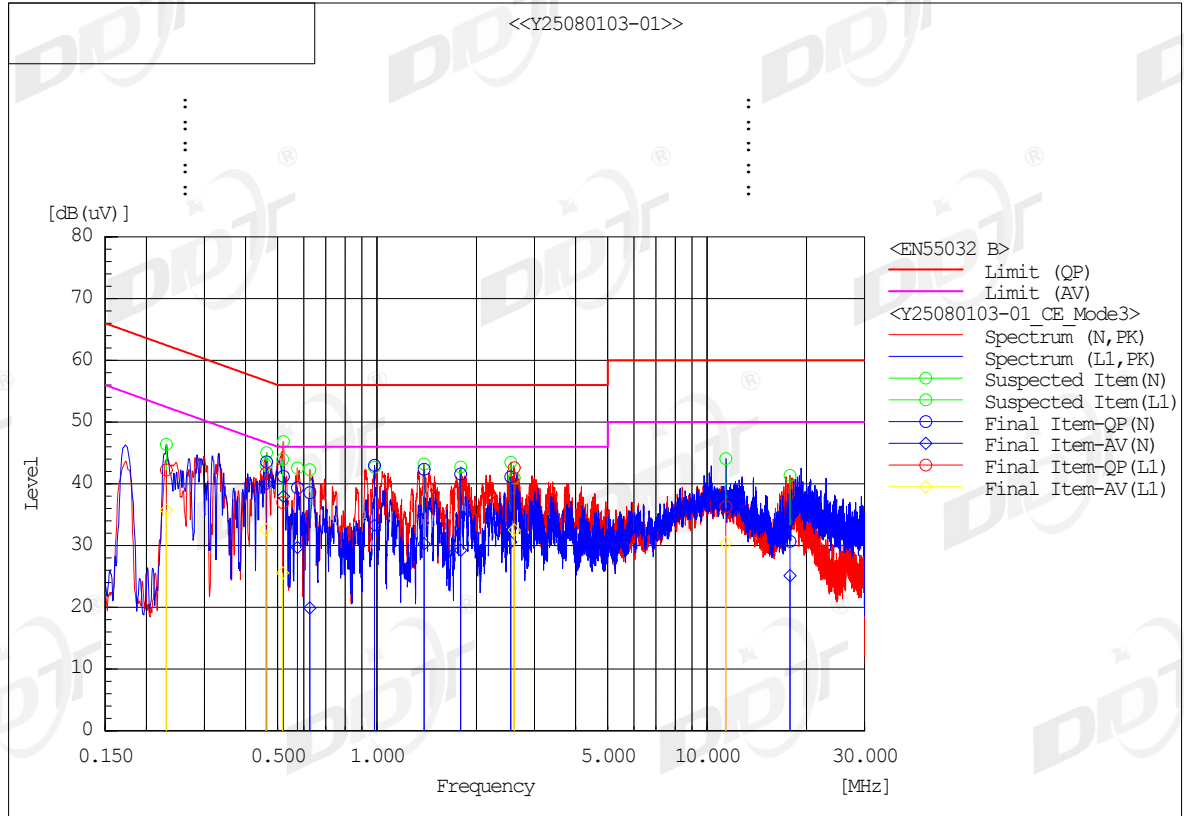

Final Result

--- N Phase ---

No.	Frequency [MHz]	Reading QP [dB(uV)]	Reading CAV [dB(uV)]	c.f [dB]	Result QP [dB(uV)]	Result CAV [dB(uV)]	Limit QP [dB(uV)]	Limit AV [dB(uV)]	Margin QP [dB]	Margin CAV [dB]
1	0.4625	33.8	30.2	9.8	43.6	40.0	56.6	46.6	13.0	6.6
2	0.5198	31.4	28.1	9.8	41.2	37.9	56.0	46.0	14.8	8.1
3	0.57387	29.6	19.9	9.8	39.4	29.7	56.0	46.0	16.6	16.3
4	0.62572	28.8	10.1	9.8	38.6	19.9	56.0	46.0	17.4	26.1
5	0.98295	33.1	23.4	9.9	43.0	33.3	56.0	46.0	13.0	12.7
6	1.38794	32.5	20.4	9.9	42.4	30.3	56.0	46.0	13.6	15.7
7	1.79311	31.7	19.3	9.9	41.6	29.2	56.0	46.0	14.4	16.8
8	2.54279	31.2	20.6	9.9	41.1	30.5	56.0	46.0	14.9	15.5
9	17.82593	20.4	14.8	10.3	30.7	25.1	60.0	50.0	29.3	24.9

--- L1 Phase ---

No.	Frequency [MHz]	Reading QP [dB(uV)]	Reading CAV [dB(uV)]	c.f [dB]	Result QP [dB(uV)]	Result CAV [dB(uV)]	Limit QP [dB(uV)]	Limit AV [dB(uV)]	Margin QP [dB]	Margin CAV [dB]
1	0.22996	32.5	26.0	9.8	42.3	35.8	62.5	52.5	20.2	16.7
2	0.461	31.9	22.8	9.8	41.7	32.6	56.7	46.7	15.0	14.1
3	0.51793	27.2	15.8	9.8	37.0	25.6	56.0	46.0	19.0	20.4
4	2.60185	32.7	22.6	9.9	42.6	32.5	56.0	46.0	13.4	13.5
5	11.40225	26.2	20.3	10.1	36.3	30.4	60.0	50.0	23.7	19.6

4 Radiated Emissions (30MHz to 1GHz)

4.1 General Information

Test date	Aug. 21, 2025	Test engineer	Wells Wei	
Climate condition	Ambient temperature	25.1°C	Relative humidity	54.6%
	Atmospheric pressure	100.2kPa		
Test place	10m Chamber			

4.2 Test Equipment

Equipment	Manufacturer	Model No.	Serial No.	Last Cal.	Cal. Interval
EMI Test Receiver	Rohde & Schwarz	ESCI	101024	Feb. 17, 2025	1 Year
BiLog Antenna	TESEQ	CBL 6112D	29068	Oct. 10, 2024	2 Year
Low Noise Amplifier	SONOMA	310N	300913	Feb. 17, 2025	1 Year
RF Selector 4CH	TOYO	NS4904N	Selector1	N/A	N/A
RF Selector 4CH	TOYO	NS4904N	Selector2	N/A	N/A
Mast Control	INNCO	CONTROLLE R CO2000	ZOAA97AZ10 0013D	N/A	N/A
BiLog Antenna	TESEQ	CBL 6112D	29069	Oct. 10, 2024	2 Year
EMI Test Receiver	Rohde & Schwarz	ESCI	101030	Feb. 17, 2025	1 Year
Low Noise Amplifier	SONOMA	310N	334532	Feb. 17, 2025	1 Year
Test Software	TOYO	EP5/RE	Ver 5.7.10	N/A	N/A

4.3 Reference Standard

EN 55032:2015,
 EN 55032:2015/A11:2020,
 EN 55032:2015/A1:2020,
 BS EN 55032:2015+A1:2020,
 BS EN 55032:2015,
 BS EN 55032:2015+A11:2020,
 CISPR 32:2015,
 CISPR 32:2015/AMD1:2019,
 AS/NZS CISPR 32:2015,
 AS/NZS CISPR 32:2015 AMD 1:2020

4.4 Test Arrangement

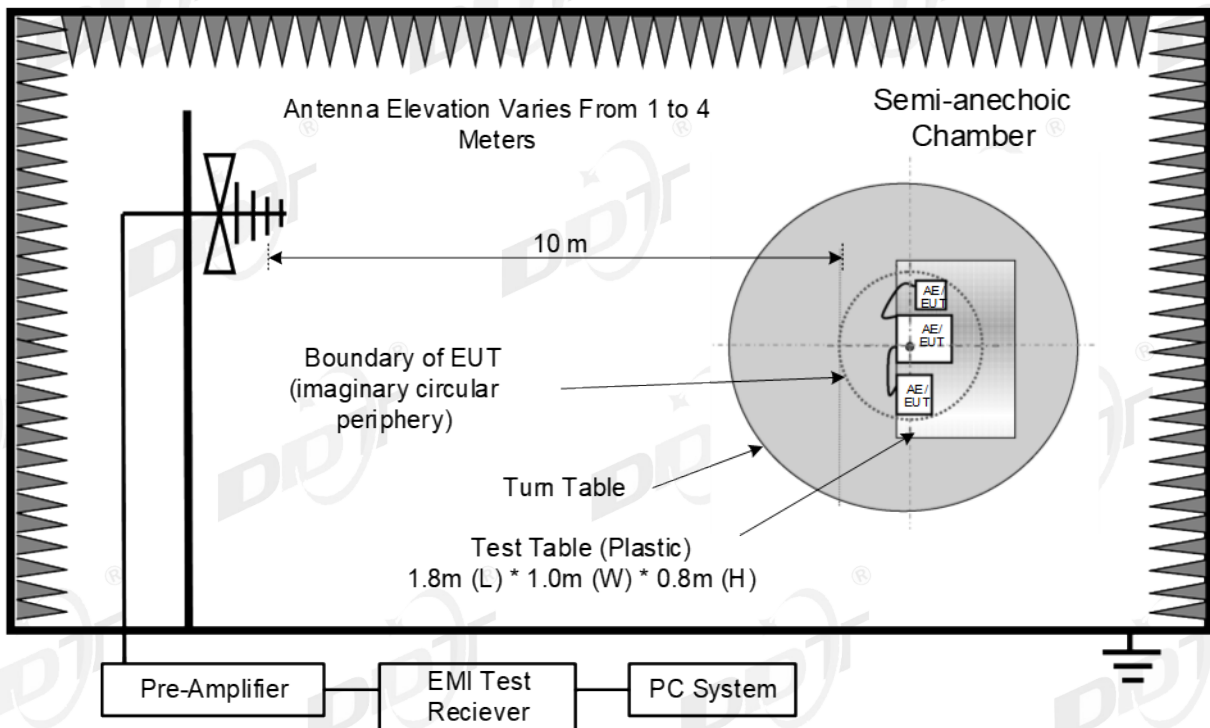

The EUT was placed on a non-metallic table, 80 cm above the ground plane inside a semi-anechoic chamber.

Test antenna was located 10m from the EUT on an adjustable mast. A pre-scan was first performed in order to find prominent radiated emissions. For final emissions measurements at each frequency of interest, the EUT were rotated and the antenna height was varied between 1m and 4m in order to maximize the emission. Measurements in both horizontal and vertical polarities were made and the data was recorded.

Spectrum frequency from 30MHz to 1GHz was investigated.

For final emissions measurements at each frequency of interest, the EUT were rotated and the antenna height was varied between 1m and 4m in order to maximize the emission. Measurements in both horizontal and vertical polarities were made and the data was recorded.

For emissions from 30MHz to 1GHz, Quasi-Peak values were measured with EMI Receiver and the bandwidth of Receiver is 120 kHz.

Final measurements consisted of 3 steps. First step, frequency fine tuning to find exact emission frequency. Second step, rechecking to search for maximum height and azimuth for interference from EUT. In final step, there are conducted measuring with quasi-peak detector for points which are detected from 1st step & 2nd step. Results checked manually and points close to the limit line were re-measured.

Pre-scan measurements were performed in all operating mode or condition. But final measurements were performed in worst cases based on pre-scan measurements.

The EUT with following test modes were pre-tested:

No.	Test Voltage	Operation Mode	Cable Length	Resolution	Rotation	Stand Position	Audio
1.	230V 50Hz	Mode1 HDMI 1	1.8m	3840*2160@120Hz	Landscape	HAS Stand-up	External Speaker
2.			1.8m	1920*1080@320Hz	Landscape	HAS Stand-up	External Speaker
3.			1.8m	800*600@60Hz	Landscape	HAS Stand-up	External Speaker

4.		1.5m	1920*1080@320Hz	Landscape	HAS Stand-up	External Speaker	
5.		1.2m	1920*1080@320Hz	Landscape	HAS Stand-up	External Speaker	
6.		1.8m	DVD	Landscape	HAS Stand-up	External Speaker	
7.	Mode2 HDMI 2	1.8m	3840*2160@120Hz	Landscape	HAS Stand-up	External Speaker	
8.		1.8m	1920*1080@320Hz	Landscape	HAS Stand-up	External Speaker	
9.		1.8m	800*600@60Hz	Landscape	HAS Stand-up	External Speaker	
10.		1.5m	1920*1080@320Hz	Landscape	HAS Stand-up	External Speaker	
11.		1.2m	1920*1080@320Hz	Landscape	HAS Stand-up	External Speaker	
12.		1.8m	DVD	Landscape	HAS Stand-up	External Speaker	
13.		Mode3 DP	1.8m	3840*2160@160Hz	Landscape	HAS Stand-up	External Speaker
14.			1.8m	1920*1080@60Hz	Landscape	HAS Stand-up	External Speaker
15.	1.8m		800*600@60Hz	Landscape	HAS Stand-up	External Speaker	
16.	1.5m		3840*2160@160Hz	Landscape	HAS Stand-up	External Speaker	
17.	1.2m		3840*2160@160Hz	Landscape	HAS Stand-up	External Speaker	
18.		The worst case above with 1.5m power cord		Landscape	HAS Stand-up	External Speaker	
19.		The worst case above with 1.2m power cord		Landscape	HAS Stand-up	External Speaker	
20.		The worst case above with 1.8m power cord		Portrait (-90 degree)	HAS Stand-up	External Speaker	
21.		The worst case above with 1.8m power cord		Portrait (-270 degree)	HAS Stand-up	External Speaker	
22.		The worst case above with 1.8m power cord		Landscape	HAS Stand-down	External Speaker	
23.		The worst case above with 1.8m power cord with scrolling "H" pattern		Landscape	HAS Stand-up	External Speaker	
24.		The worst case 1920*1080@60Hz with 1.8m power cord		Landscape	HAS Stand-up	Without Headphone	
25.		The worst case 1920*1080@60Hz with 1.8m power cord		Landscape	HAS Stand-up	With Headphone	
26.	110V 60Hz	The worst case above with 1.8m power cord		Landscape	HAS Stand-up	External Speaker	

4.5 Test Specification and Limit

Class B

Frequency	Field Strengths Limits at 10m measuring distance dB(μ V)/m
30MHz to 230MHz	30
230MHz to 1000MHz	37

Note: (1) The smaller limit shall apply at the cross point between two frequency bands.

(2) Distance is the distance in meters between the measuring instrument, antenna and the closest point of any part of the device or system.

Note for test result

Note1): According pre-test, the worst test modes decided as below and reported. Only data of worst mode was reported in test result.

Note2) (P): Abbreviation of Antenna Polarity

Note3) Receiving antenna polarization: Horizontal and/or Vertical. Antenna Height: 1 m to 4 m

Note4) Level QP (Quasi-Peak) = Reading QP + Factor

Note5) Factor = Antenna Factor + Cable Loss - Amp. Gain

Note6) Margin = Limit – Level QP

4.6 Test Result

Sample No.	Operation Mode	Remarks	Result
Y25080103-01	Mode 1 HDMI1	Final measurement , minimum margin 4.0 dB	Pass
Y25080103-01	Mode 2 HDMI2	Pre-scan measurement	Pass
Y25080103-01	Mode 3 DP	Pre-scan measurement	Pass

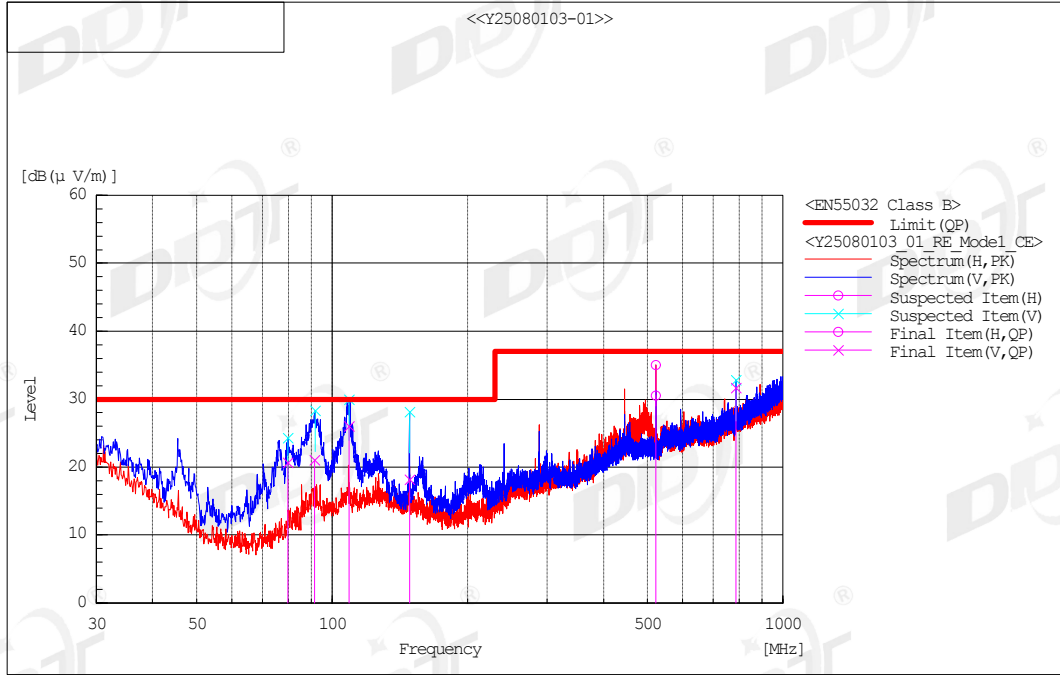

Final Result

No.	Frequency (P) [MHz]	Reading QP [dB (μ V)]	c.f [dB (1/m)]	Result QP [dB (μ V/m)]	Limit QP [dB (μ V/m)]	Margin QP [dB]	Height [cm]	Angle [°]	System
1	109.119	V 37.1	-11.1	26.0	30.0	4.0	192.0	278.9	2
2	787.328	V 28.6	3.1	31.7	37.0	5.3	197.0	190.5	2
3	522.154	H 32.2	-1.7	30.5	37.0	6.5	117.0	157.4	1
4	91.296	V 34.8	-13.7	21.1	30.0	8.9	106.0	118.3	2
5	79.834	V 36.5	-15.8	20.7	30.0	9.3	159.0	307.9	2
6	148.504	V 29.9	-11.7	18.2	30.0	11.8	113.0	337.3	2

5 Radiated Emissions (Above 1GHz)

5.1 General Information

Test date	Aug. 25, 2025	Test engineer	Wendy Sun	
Climate condition	Ambient temperature	25.0°C	Relative humidity	47.4%
	Atmospheric pressure	100.6kPa		
Test place	3m Chamber			

5.2 Test Equipment

Equipment	Manufacturer	Model No.	Serial No.	Last Cal.	Cal. Interval
EMI Test Receiver	Rohde & Schwarz	ESU26	100244	Feb. 17, 2025	1 Year
Broadband Horn Antenna	TESEQ	BHA 9118	31754	Oct. 11, 2023	2 Year
Amplifier	COM-MW	DPA8 1000 18000-1012	09211739	Feb. 17, 2025	1 Year
Test Software	TOYO	EP5/RE	Ver 5.7.10	N/A	N/A

5.3 Reference Standard

EN 55032:2015,
 EN 55032:2015/A11:2020,
 EN 55032:2015/A1:2020,
 BS EN 55032:2015+A1:2020,
 BS EN 55032:2015,
 BS EN 55032:2015+A11:2020,
 CISPR 32:2015,
 CISPR 32:2015/AMD1:2019,
 AS/NZS CISPR 32:2015,
 AS/NZS CISPR 32:2015 AMD 1:2020

5.4 Test Arrangement

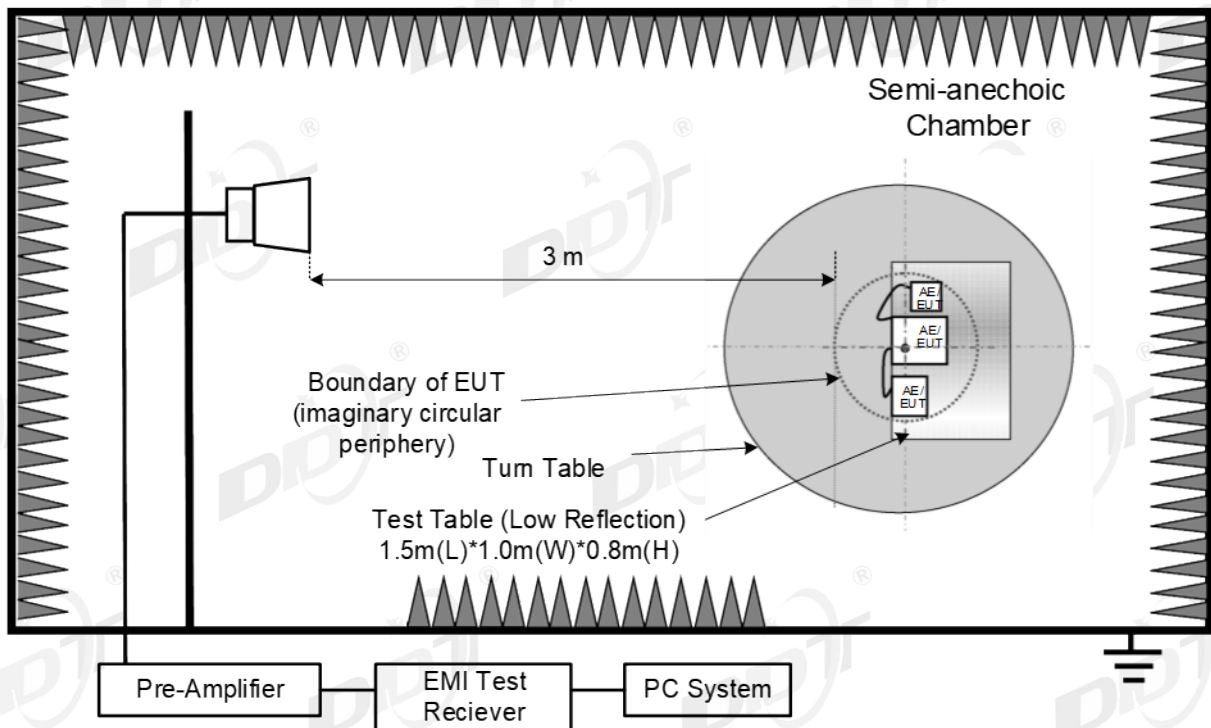

The highest internal source of an EUT is defined as the highest frequency generated or used within the EUT or on which the EUT operates or tunes.

If the highest frequency of the internal sources of the EUT is less than 108 MHz, the measurement shall only be made up to 1 GHz.

If the highest frequency of the internal sources of the EUT is between 108 MHz and 500 MHz, the measurement shall only be made up to 2 GHz.

If the highest frequency of the internal sources of the EUT is between 500 MHz and 1 GHz, the measurement shall only be made up to 5 GHz.

If the highest frequency of the internal sources of the EUT is above 1 GHz, the measurement shall be made up to 5 times the highest frequency or 6 GHz, whichever is less.

For emissions above 1GHz, both Peak and Average level were measured with Spectrum Analyzer, and the RBW is set at 1MHz.

Measurements within 20 dB of the limit were then maximized by adjusting turntable position.

Final measurements were made using an C/Average detector.

Results checked manually and points close to the limit line were re-measured.

Pre-scan measurements were performed in all operating mode or resolution. But final measurements were performed in worst cases based on pre-scan measurements.

The EUT with following test modes were pre-tested:

No.	Test Voltage	Operation Mode	Cable Length	Resolution	Rotation	Stand Position	Audio
1.	230V 50Hz	Mode1 HDMI 1	1.8m	3840*2160@120Hz	Landscape	HAS Stand-up	External Speaker
2.			1.8m	1920*1080@320Hz	Landscape	HAS Stand-up	External Speaker
3.			1.8m	800*600@60Hz	Landscape	HAS Stand-up	External Speaker
4.			1.5m	1920*1080@320Hz	Landscape	HAS Stand-up	External Speaker

5.		1.2m	1920*1080@320Hz	Landscape	HAS Stand-up	External Speaker	
6.		1.8m	DVD	Landscape	HAS Stand-up	External Speaker	
7.	Mode2 HDMI 2	1.8m	3840*2160@120Hz	Landscape	HAS Stand-up	External Speaker	
8.		1.8m	1920*1080@320Hz	Landscape	HAS Stand-up	External Speaker	
9.		1.8m	800*600@60Hz	Landscape	HAS Stand-up	External Speaker	
10.		1.5m	1920*1080@320Hz	Landscape	HAS Stand-up	External Speaker	
11.		1.2m	1920*1080@320Hz	Landscape	HAS Stand-up	External Speaker	
12.		1.8m	DVD	Landscape	HAS Stand-up	External Speaker	
13.		Mode3 DP	1.8m	3840*2160@160Hz	Landscape	HAS Stand-up	External Speaker
14.			1.8m	1920*1080@60Hz	Landscape	HAS Stand-up	External Speaker
15.	1.8m		800*600@60Hz	Landscape	HAS Stand-up	External Speaker	
16.	1.5m		3840*2160@160Hz	Landscape	HAS Stand-up	External Speaker	
17.	1.2m		3840*2160@160Hz	Landscape	HAS Stand-up	External Speaker	
18.		The worst case above with 1.5m power cord		Landscape	HAS Stand-up	External Speaker	
19.		The worst case above with 1.2m power cord		Landscape	HAS Stand-up	External Speaker	
20.		The worst case above with 1.8m power cord		Portrait (-90 degree)	HAS Stand-up	External Speaker	
21.		The worst case above with 1.8m power cord		Portrait (-270 degree)	HAS Stand-up	External Speaker	
22.		The worst case above with 1.8m power cord		Landscape	HAS Stand-down	External Speaker	
23.		The worst case above with 1.8m power cord with scrolling "H" pattern		Landscape	HAS Stand-up	External Speaker	
24.		The worst case 1920*1080@60Hz with 1.8m power cord		Landscape	HAS Stand-up	Without Headphone	
25.		The worst case 1920*1080@60Hz with 1.8m power cord		Landscape	HAS Stand-up	With Headphone	
26.	110V 60Hz	The worst case above with 1.8m power cord		Landscape	HAS Stand-up	External Speaker	

5.5 Test Specification and Limit

Class B

Frequency range Limits (GHz)	Limits of Class B, dB(μ V/m)	
	Peak	C/Average
1 ~ 3	70	50
3 ~ 6	74	54
Note: The lower limit shall apply at the transition frequency		

Note for test result

Note1): According pre-test, the worst test modes decided as below and reported. Only data of worst mode was reported in test result.

Note2) (P) : Abbreviation of Antenna Polarity

Note3) Reading PK / C/AV: Received raw Peak / C/Average signal

Note4) Level PK / C/AV = Reading PK / C/AV + Factor, Real signal Peak / C/Average level

Note5) Factor = Antenna factor + Cable loss – Amplifier gain

Note6) Margin PK / C/AV = Limit – Level PK / C/AV

5.6 Test Result

Sample No.	Operation Mode	Remarks	Result
Y25080103-01	Mode 1 HDMI1	Final measurement,minimum margin 12.7dB	Pass
Y25080103-01	Mode 2 HDMI2	Pre-scan measurement	Pass
Y25080103-01	Mode 3 DP	Pre-scan measurement	Pass

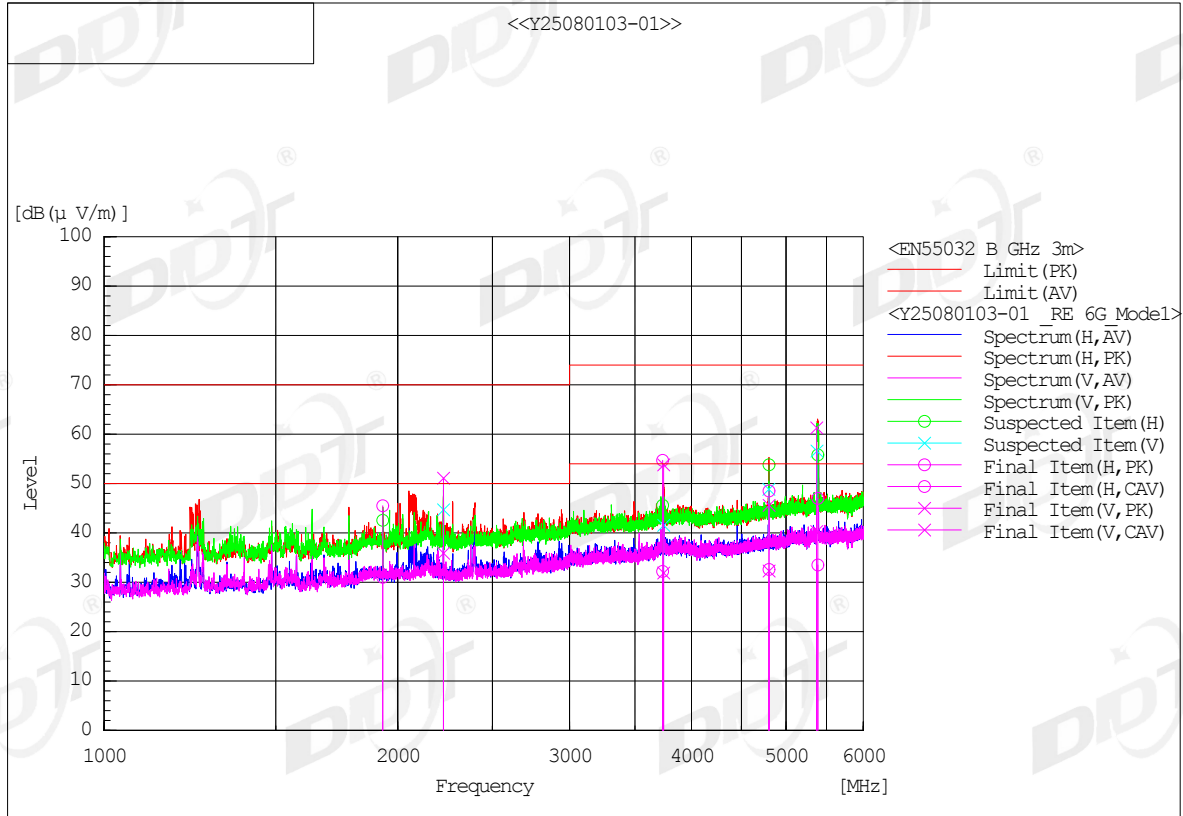

Final Result

No.	Frequency [MHz]	(P)	Reading PK [dB(µ V)]	Reading CAV [dB(µ V)]	c.f [dB(1/m)]	Result PK [dB(µ V/m)]	Result CAV [dB(µ V/m)]	Limit PK [dB(µ V/m)]	Limit AV [dB(µ V/m)]	Margin PK [dB]	Margin CAV [dB]	Height [cm]	Angle [°]	Remark
1	5375.313	V	74.3	53.3	-13.0	61.3	40.3	74.0	54.0	12.7	13.7	115.0	138.4	
2	2227.536	V	73.7	58.5	-22.6	51.1	35.9	70.0	50.0	18.9	14.1	126.0	193.0	
3	1930.582	H	68.1	53.6	-22.6	45.5	31.0	70.0	50.0	24.5	19.0	133.0	159.1	
4	5389.648	H	59.9	46.4	-12.9	47.0	33.5	74.0	54.0	27.0	20.5	144.0	236.7	
5	4802.532	H	63.3	47.4	-14.8	48.5	32.6	74.0	54.0	25.5	21.4	151.0	55.4	
6	4801.633	V	60.4	47.1	-14.8	45.6	32.3	74.0	54.0	28.4	21.7	167.0	278.4	
7	3736.087	H	71.7	49.2	-17.0	54.7	32.2	74.0	54.0	19.3	21.8	174.0	355.7	
8	3745.397	V	70.8	48.9	-17.0	53.8	31.9	74.0	54.0	20.2	22.1	195.0	186.9	

6 Harmonic Current Emissions

6.1 General Information

Test date	Aug. 13, 2025	Test engineer	Freya Wei	
Climate condition	Ambient temperature	23.3°C	Relative humidity	57.4%
	Atmospheric pressure	101.0kPa		
Test place	Shield Room 2#			

6.2 Test Equipment

Equipment	Manufacturer	Model No.	Serial No.	Last Cal.	Cal. Interval
High Performance Linear AC power sources	Pacific Power Source	360-AMX	1234	Feb. 17, 2025	1 Year
High Performance Linear AC power sources	Pacific Power Source	360-AMX	1235	Feb. 17, 2025	1 Year
Harmonics and Flicker Analyzer	Newtons4th Ltd	PPA5511	162-04584	Nov. 16, 2024	1 Year
IEC Reference Impedance Network	Voltech	IEC61000-3	IG164/2021	Nov. 16, 2024	1 Year
Test Software	TOYO	EP5/CE	Ver 5.4.40	N/A	N/A

6.3 Reference Standard

EN 61000-3-2:2014,
 EN IEC 61000-3-2:2019/A1:2021,
 EN IEC 61000-3-2:2019/A2:2024,
 EN IEC 61000-3-2:2019,
 BS EN IEC 61000-3-2:2019+A1:2021,
 BS EN IEC 61000-3-2:2019+A2:2024,

6.4 Test Arrangement

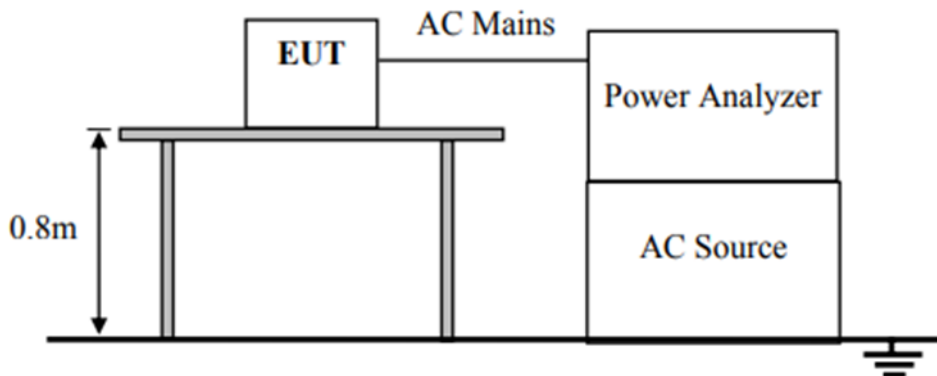

6.5 Test Specification and Limit

Limits for Class D equipment

Harmonic order	Maximum permissible harmonic current per watt	Maximum permissible harmonic current
n	mA/W	A
3	3.4	2.30
5	1.9	1.14
7	1.0	0.77
9	0.5	0.40
11	0.35	0.33
13 ≤ n ≤ 39 (odd harmonics only)	3.85/n	See Table 1

6.6 Test Result

Sample No.	Operation Mode	Remarks	Result
Y25080103-01	Mode 3 DP	Rated Power < 75W	Pass

Page		
Test Settings		
Class	Class D	
Mode	Measure	
Equipment Under Test		
Brand	N/A	
Model	Y25080103-01	
Serial	N/A	
Impedance Network ID	N/A	
Test Conditions		
	User Entered	Measured
Rated Voltage	230.000 V	231.362 V
Rated Current	N/A	310.662 mA
Rated Frequency	50.000 Hz	50.000 Hz
Rated Power	N/A	65.336 W
Additional Test Information		
Measured Power Factor	0.909	
Max Current THD	21.34%	
Max THC	0.0646A	
Max Power	65.422 W	
Max F. Current	303.930 mA	
Average F. Current	303.562 mA	
Minimum Current	100mA	
Test Duration	2.5 minutes	
Additional Test Details		
Operator	N/A	
Lab Name	N/A	
Location	N/A	
Notes		
Signature		
Results	Test - N/A. Rated Power < 75W	

7 Voltage Changes, Voltage Fluctuations and Flicker

7.1 General Information

Test date	Aug. 13, 2025	Test engineer	Freya Wei	
Climate condition	Ambient temperature	23.3°C	Relative humidity	57.4%
	Atmospheric pressure	101.0kPa		
Test place	Shield Room 2#			

7.2 Test Equipment

Equipment	Manufacturer	Model No.	Serial No.	Last Cal.	Cal. Interval
High Performance Linear AC power sources	Pacific Power Source	360-AMX	1234	Feb. 17, 2025	1 Year
High Performance Linear AC power sources	Pacific Power Source	360-AMX	1235	Feb. 17, 2025	1 Year
Harmonics and Flicker Analyzer	Newtons4th Ltd	PPA5511	162-04584	Nov. 16, 2024	1 Year
IEC Reference Impedance Network	Voltech	IEC61000-3	IG164/2021	Nov. 16, 2024	1 Year
Test Software	N4L	IEC Soft	Ver 2.4e	N/A	N/A

7.3 Reference Standard

EN 61000-3-3:2013,
 EN 61000-3-3:2013/A1:2019,
 EN 61000-3-3:2013/A2:2021,
 EN 61000-3-3:2013/A2:2021/AC:2022-01,
 BS EN 61000-3-3:2013,
 BS EN 61000-3-3:2013+A1:2019,
 BS EN 61000-3-3:2013+A2:2021,

7.4 Test Arrangement

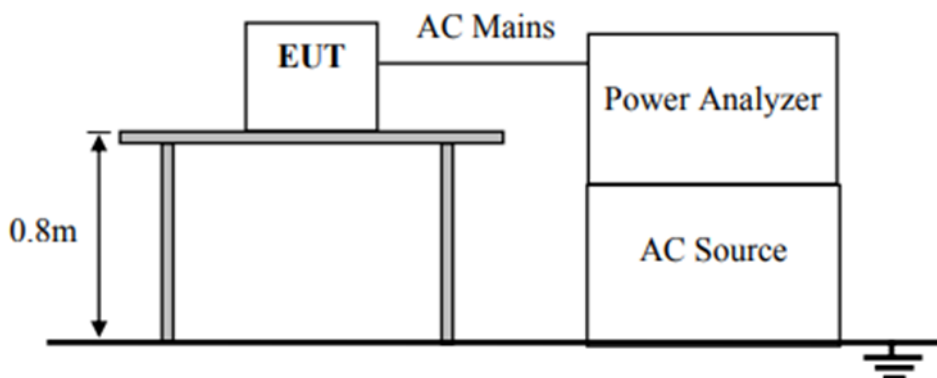

7.5 Test Specification and Limit

short-term flicker indicator, Pst	the relative steady-state voltage change, dc	the value of d(t) during a voltage change, d(t) >3.3 %	the maximum relative voltage change, dmax
1.0	3.3 %	500 ms	4 %

7.6 Test Result

Sample No.	Operation Mode	Remarks	Result
Y25080103-01	Mode 3 DP	N/A	Pass

Page 1/3		
Test Settings		
Class	Voltage	
Mode	Normal - 4%	
Minimum Current	300mA	
PST	10.00 minutes	
PLT	1 PSTs	
Equipment Under Test		
Brand	N/A	
Model	Y25080103-01	
Serial	N/A	
Impedance Network ID	N/A	
Test Conditions		
	User Entered	Measured
Rated Voltage	230.000 V	231.298 V
Rated Current	N/A	N/A
Rated Frequency	50.000 Hz	50.000 Hz
Rated Power	N/A	N/A
D max	0.0818% (Limit: 4%)	
T max	0.0000 s (Limit: 0.5 s)	
DC max	0.0037% (Limit: 3.3%)	
Additional Test Details		
Operator	N/A	
Lab Name	N/A	
Location	N/A	
Notes		
Signature		
Results	Phase1: PASS	

8 Electrostatic Discharge Immunity

8.1 General Information

Test date	Sep. 01, 2025	Test engineer	Ben Hu	
Climate condition	Ambient temperature	24.7°C	Relative humidity	50.1%
	Atmospheric pressure	100.9kPa		
Test place	Shield Room 3#			

8.2 Test Equipment

Equipment	Manufacturer	Model No.	Serial No.	Last Cal.	Cal. Interval
Discharge Network	TESEQ	INA 4380	0011	May. 12, 2025	1 Year
ESD Simulator	TESEQ	NSG 437	407	May. 12, 2025	1 Year

8.3 Reference Standard

EN 55035:2017,
EN 55035:2017/A11:2020,
BS EN 55035:2017+A11:2020,
CISPR 35:2016,
IEC 61000-4-2:2025

8.4 Test Arrangement

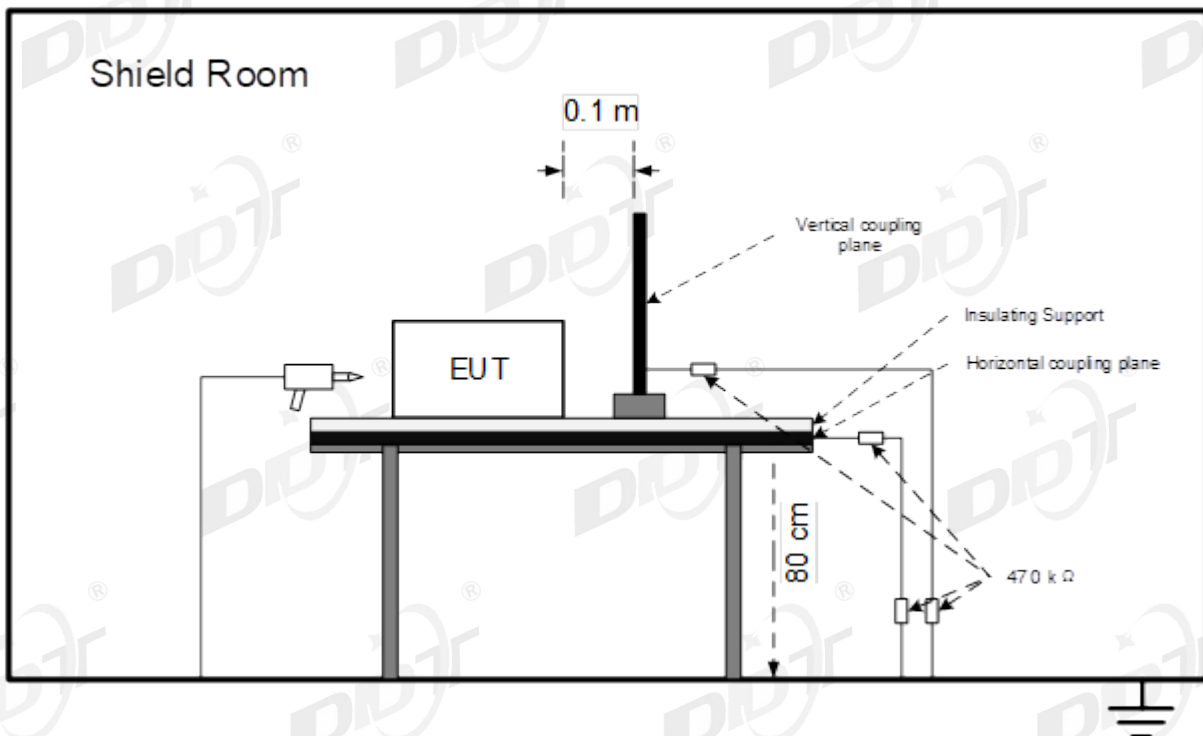

Air Discharge:

The test was applied on non-conductive surfaces of EUT. The round discharge tip of the discharge electrode was approached as fast as possible to touch the EUT. After each discharge, the discharge electrode was removed from the EUT. The generator was re-triggered for a new single discharge and repeated 20 times for each pre-selected test point. This procedure was repeated

until all the air discharge completed.

Contact Discharge:

All the procedure was same as air discharge. Except that the generator was re-triggered for a new single discharge. The tip of the discharge electrode was touching the EUT before the discharge switch was operated.

Indirect discharge for horizontal coupling plane:

At least 20 single discharges were applied to the horizontal coupling plane, at points on each side of the EUT. The discharge electrode positions vertically at a distance of 0.1m from the EUT and with the discharge electrode touching the coupling plane.

Indirect discharge for vertical coupling plane:

At least 20 single discharges were applied to the center of one vertical edge of the coupling plane. The coupling plane, of dimensions 0.5m X 0.5m, was placed parallel to, and positioned at a distance of 0.1m from the EUT. Discharges were applied to the coupling plane, with this plane in sufficient different positions that the four faces of the EUT are completely illuminated.

8.5 Test Specification and Limit

Test Level		Performance Criteria
Air Discharge	±2kV, ±4kV, ±8kV	B
Contact Discharge	±4kV	

8.6 Test Result

Sample No. Y25080103-01						
Operation Mode	Discharge Method	Test Level	Test Point	Required	Observation	Result
Mode 1 HDMI1	Contact Discharge	±4kV	10,11	B	B ⁽²⁾	Pass
Mode 1 HDMI1	Air Discharge	±2kV	1,2,3,4,5,6,7,8,9	B	A ⁽¹⁾	Pass
Mode 1 HDMI1	Air Discharge	±4kV	1,2,3,4,5,6,7,8,9	B	B ⁽²⁾	Pass
Mode 1 HDMI1	Air Discharge	±8kV	1,2,3,4,5,6,7,8,9	B	B ⁽²⁾	Pass
Remark						
(1)	Operation as intend, no loss of function during test and after test.					
(2)	During the testing process, the display screen experienced a screen-off phenomenon. After the test was completed, it automatically returned to normal without any manual intervention.					
Test Point						
No.	Description	No.	Description	No.	Description	
1	Panel	2	button	3	light	
4	Gap	5	USB-A Port	6	USB-B Port	
7	HDMI Port	8	DP Port	9	Audio Out Port	
10	Shield Cover	11	Coupling Planes	/	/	

Discharge Point Photo

Contact



Air

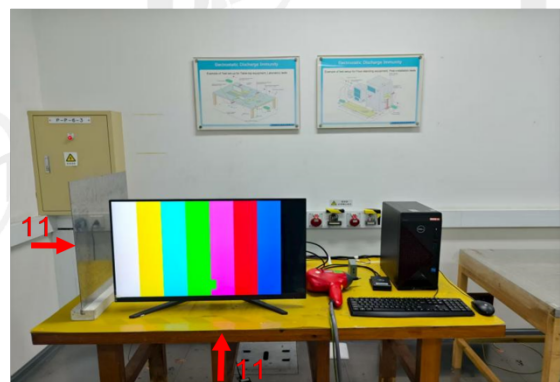
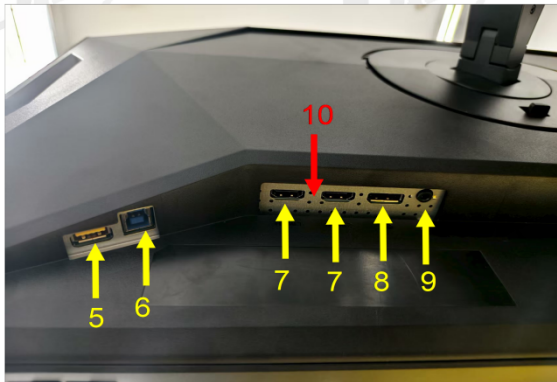
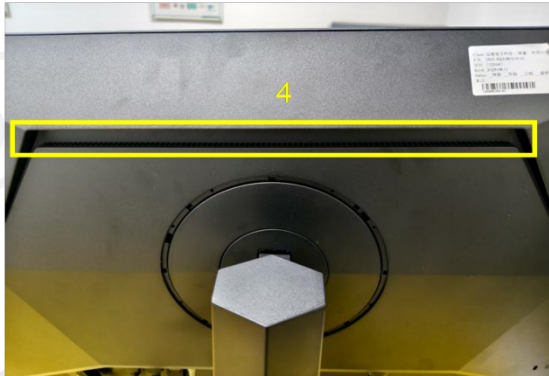
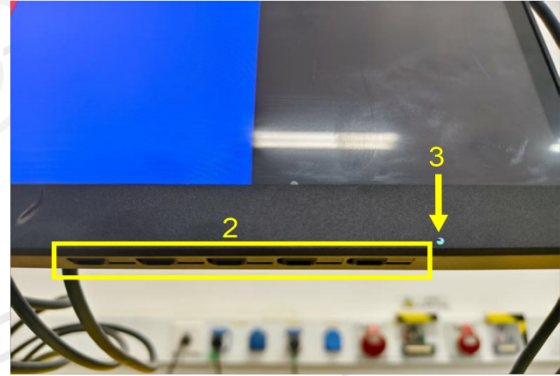

9 Radiated, Radio-frequency, Electromagnetic Field Immunity

9.1 General Information

Test date	Aug. 27, 2025	Test engineer	Wendy Sun	
Climate condition	Ambient temperature	25.1°C	Relative humidity	51.4%
	Atmospheric pressure	100.7kPa		
Test place	3m Chamber			

9.2 Test Equipment

Equipment	Manufacturer	Model No.	Serial No.	Last Cal.	Cal. Interval
Power Meter	Rohde & Schwarz	NRP	102424	Feb. 17, 2025	1 Year
Average Power Sensor	Rohde & Schwarz	NRP-Z91	100937	Feb. 17, 2025	1 Year
Average Power Sensor	Rohde & Schwarz	NRP-Z91	100938	Feb. 17, 2025	1 Year
Audio Analyzer	Rohde & Schwarz	UPV	101525	Feb. 17, 2025	1 Year
Stacked Logarithmic-Periodic Broadband Antenna	SCHWARZBE CK	STLP 9149	9149-059	N/A	N/A
Microwave Signal Generator	Rohde & Schwarz	SMB100A	104909	Feb. 17, 2025	1 Year
Stacked Logarithmic-Periodic Broadband Antenna	SCHWARZBE CK	STLP 9128 E special	9128ES-171	N/A	N/A
RF Switch for Radiated	SKET	RS_DC06G-AMC-3C	SK2020081901	N/A	N/A
Power Amplifier	SKET	HAP_01G032 G-250W	202104178	Aug. 01, 2025	1 Year
Power Amplifier	SKET	HAP_03G06G -75W	SK202106221	Aug. 01, 2025	1 Year
Power Amplifier(Comb iner)	SKET	HAP_80M200 M/200M1G-2000/1000W	202102154	Aug. 01, 2025	1 Year
Test Software	SKET	EMC-S	V2.1.4.15	N/A	N/A

9.3 Reference Standard

EN 55035:2017,
 EN 55035:2017/A11:2020,
 BS EN 55035:2017+A11:2020,
 CISPR 35:2016,
 IEC 61000-4-3:2020

9.4 Test Arrangement

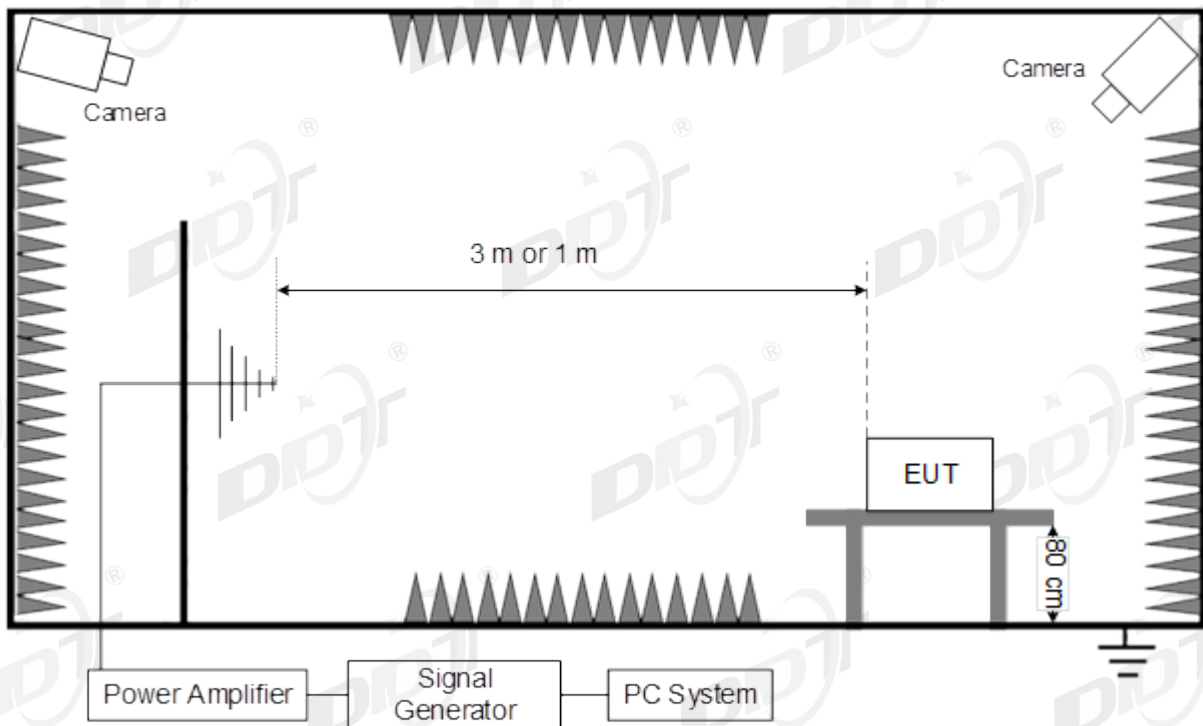

The EUT is initially placed with one face coincident with the calibration plane. The EUT face being illuminated shall be contained within the UFA unless partial illumination is being applied.

The frequency ranges to be considered are swept with the signal modulated, pausing to adjust the RF signal level or to switch oscillators and antennas as necessary.

Where the frequency range is swept incrementally, the step size shall not exceed 1 % of the preceding frequency value.

The dwell time of the amplitude modulated carrier at each frequency shall not be less than the time necessary for the EUT to be exercised and to respond, but shall in no case be less than 0,5 s. The sensitive frequencies (e.g., clock frequencies) shall be analyzed separately according to the requirements in product standards.

The test shall normally be performed with the generating antenna facing each side of the EUT.

When equipment can be used in different orientations (i.e. vertical or horizontal) all sides shall be exposed to the field during the test. When technically justified, some EUTs can be tested by exposing fewer faces to the generating antenna. In other cases, as determined for example by the type and size of EUT or the frequencies of test, more than four azimuths may need to be exposed.

The polarization of the field generated by each antenna necessitates testing each selected side twice, once with the antenna positioned vertically and again with the antenna positioned horizontally.

9.5 Test Specification and Limit

Swept frequency test		Performance Criteria
Frequency (MHz)	80 to 1000	A
Field Strength	3V/m rms voltage level of the unmodulated signal	
Modulation	AM modulated to a depth of 80% by a sine wave of 1kHz (note 1)	
Step Size	1% increments	
Dwell time	< 5 Sec.	

Spot frequency test		Performance Criteria
Frequency (MHz)	1800, 2600, 3500, 5000	A
Field Strength	3V/m rms voltage level of the unmodulated signal	
Modulation	AM modulated to a depth of 80% by a sine wave of 1kHz (note 1)	
Dwell time	< 5 Sec.	

Note 1: The 1kHz modulation may be replaced by a different audio modulation frequency more appropriate for a given EUT if, for example, 1kHz is not within the operating audio range of the EUT.

For audio output function (if applied):

Performance criterion A

During the test the audio output function shall be maintained. The measured acoustic interference ratio and/or the measured electrical interference ratio during the test shall be -20 dB or better.

9.6 Test Result

Sample No. Y25080103-01						
Frequency Range & Field Strength						
80MHz ~ 1000MHz				3V/m		
1800MHz, 2600MHz, 3500MHz, 5000MHz				3V/m		
Steps: 1%		Dwell time: 1s		Modulation: 1KHz 80% AM		
Operation Mode	EUT Position	Antenna: Horizontal		Antenna: Vertical		Result
		Required	Observation	Required	Observation	
Mode 1 HDMI1	Front side	A	A ⁽¹⁾	A	A ⁽¹⁾	Pass
Mode 1 HDMI1	Back side	A	A ⁽¹⁾	A	A ⁽¹⁾	Pass
Mode 1 HDMI1	Left side	A	A ⁽¹⁾	A	A ⁽¹⁾	Pass
Mode 1 HDMI1	Right side	A	A ⁽¹⁾	A	A ⁽¹⁾	Pass
Remark						
(1)	Operation as intend, no loss of function during test and after test.					

Audio output function result: this device without audio output function.

Method	Port	Acoustic interference ratio L1-L0 (dB) Required: ≤-20dB	Result
<input type="checkbox"/> acoustic measurement	N/A	N/A	N/A
<input checked="" type="checkbox"/> electrical measurement	Audio out	-42.40	Pass

10 Electrical Fast Transient/Burst Immunity

10.1 General Information

Test date	Sep. 01, 2025	Test engineer	Ben Hu	
Climate condition	Ambient temperature	24.7°C	Relative humidity	50.1%
	Atmospheric pressure	100.9kPa		
Test place	Shield Room 3#			

10.2 Test Equipment

Equipment	Manufacturer	Model No.	Serial No.	Last Cal.	Cal. Interval
Multifunctional Generator	EMTEST	UCS 500N7.1	P1303110687	Feb. 17, 2025	1 Year
3-Phase Coupling Decoupling Network	EMTEST	CNI 503B7	V1250114298	Feb. 17, 2025	1 Year
Test Software	EM TEST	iec.control	Version 5.2.3	N/A	N/A

10.3 Reference Standard

EN 55035:2017,
 EN 55035:2017/A11:2020,
 BS EN 55035:2017+A11:2020,
 CISPR 35:2016,
 IEC 61000-4-4:2012

10.4 Test Arrangement

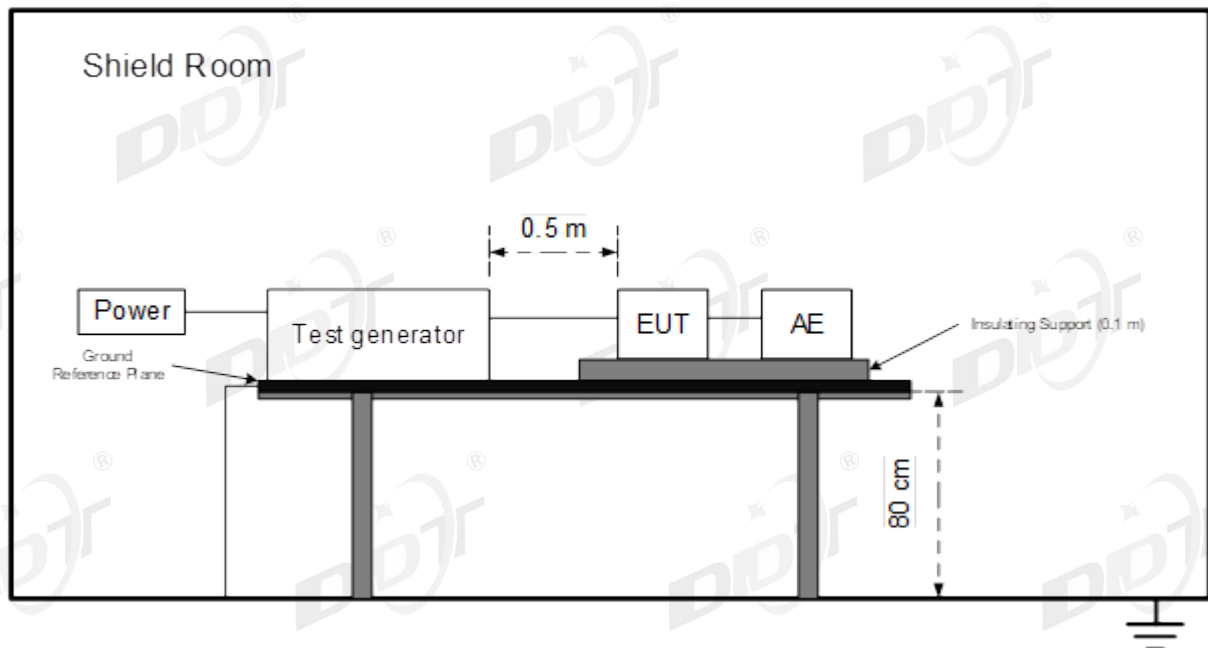

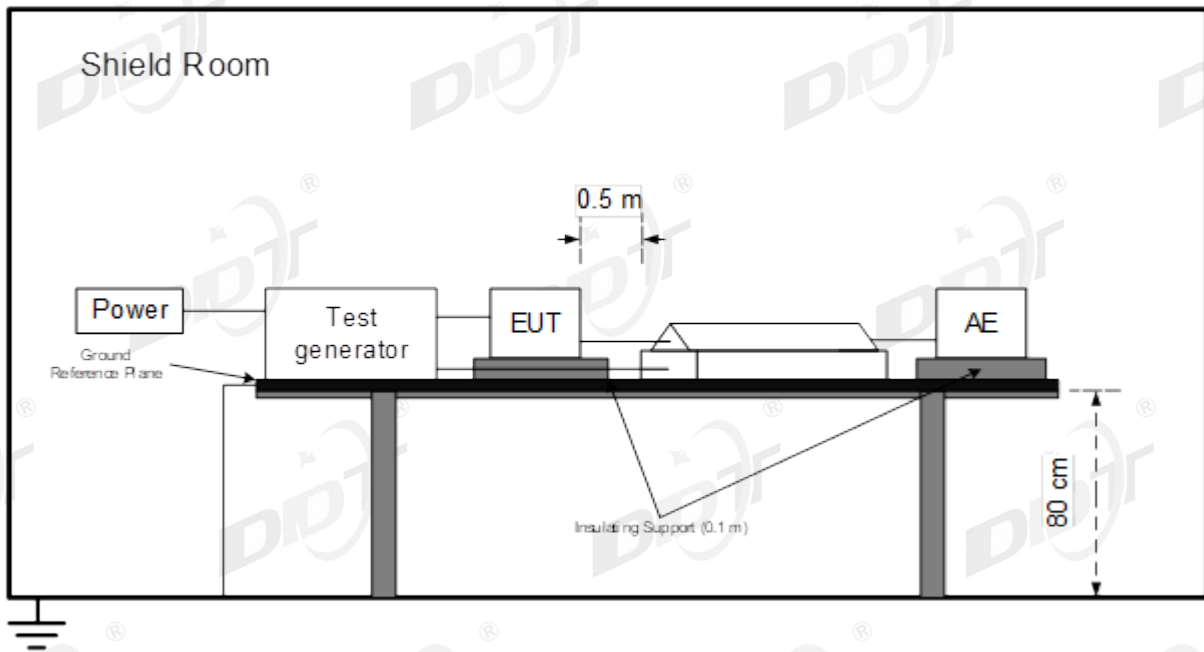

The EUT and its simulators were placed on the ground reference plane and were insulated from it by an insulating support $0.1\text{m} \pm 0.01\text{m}$ thick.

The minimum distance between the EUT and all other conductive structures (e.g. the walls of a shielded room), except the ground reference plane shall be more than 0,5 m.

All cables to the EUT shall be placed on the insulation support 0,1 m above the ground reference plane. Cables not subject to electrical fast transients shall be routed as far as possible from the cable under test to minimize the coupling between the cables.

10.5 Test Specification and Limit

Test Level		Performance Criteria
Test voltage	$\pm 1\text{kV}$ For AC mains Port	$\pm 0.5\text{kV}$ for DC input or signal Port
Repetition Frequency	5kHz	5kHz
Burst Duration	15ms	15ms
Burst Period	300ms	300ms
Inject Time(s)	120s	120s
Inject Method	Direct for AC mains port	Direct for signal port Direct for dc input port
Inject Line	AC Mains of adapter	DC input of adapter or Capacitive coupling clamp

Note: This test shall be additionally performed on analogue/digital data ports, and DC network power ports, of radio equipment and associated ancillary equipment, if the cables may be longer than 3 m.

10.6 Test Result

Sample No. Y25080103-01						
Injected Port	AC Mains Power		Coupling	Direct		
Burst Period:	300ms		Test Time:	120s		
Repetition Frequency	5KHz		Burst Durations	15ms		
Operation Mode	Line	Test Voltage	Required	Observation		Result
				Positive	Negative	
Mode 3 DP	L	±1kV	B	B ⁽¹⁾	B ⁽¹⁾	Pass
Mode 3 DP	N	±1kV	B	B ⁽¹⁾	B ⁽¹⁾	Pass
Mode 3 DP	PE	±1kV	B	B ⁽¹⁾	B ⁽¹⁾	Pass
Mode 3 DP	L-N	±1kV	B	B ⁽¹⁾	B ⁽¹⁾	Pass
Mode 3 DP	L-PE	±1kV	B	B ⁽¹⁾	B ⁽¹⁾	Pass
Mode 3 DP	N-PE	±1kV	B	B ⁽¹⁾	B ⁽¹⁾	Pass
Mode 3 DP	L-N-PE	±1kV	B	B ⁽¹⁾	B ⁽¹⁾	Pass
Remark						
(1)	During the testing process, the display screen experienced a screen-off phenomenon. After the test was completed, it automatically returned to normal without any manual intervention.					

11 Surge Immunity

11.1 General Information

Test date	Sep. 01, 2025	Test engineer	Ben Hu	
Climate condition	Ambient temperature	24.7°C	Relative humidity	50.1%
	Atmospheric pressure	100.9kPa		
Test place	Shield Room 3#			

11.2 Test Equipment

Equipment	Manufacturer	Model No.	Serial No.	Last Cal.	Cal. Interval
3-Phase Coupling Decoupling Network	EMTEST	CNI 503B7	V1250114298	Feb. 17, 2025	1 Year
Multifunctional Generator	EMTEST	UCS 500N7.1	P1303110687	Feb. 17, 2025	1 Year
Test Software	EM TEST	iec.control	Version 5.2.3	N/A	N/A

11.3 Reference Standard

EN 55035:2017,
 EN 55035:2017/A11:2020,
 BS EN 55035:2017+A11:2020,
 CISPR 35:2016,
 IEC 61000-4-5:2014+AMD1:2017 CSV

11.4 Test Arrangement

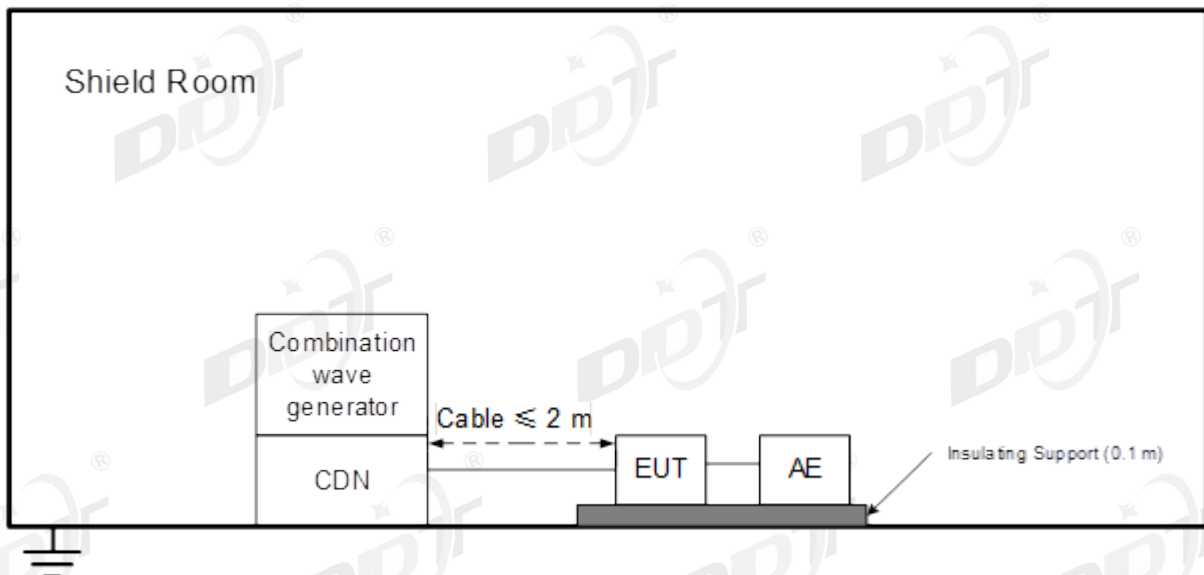

EUT should be configured in representative operating conditions.

At least 5 positive and 5 negative (polarity) tests with a maximum 1/min repetition rate are applied during test.

Different phase angles are done individually, if applied.

Record the EUT operating situation during compliance test and decide the EUT immunity criterion for above each test.

11.5 Test Specification and Limit

Test level for AC mains ports		Performance Criterion
Line to Line	1kV 1.2/50(8/20) μ s	B
Line to Ground	2kV 1.2/50(8/20) μ s	B
Analogue/digital data port, Port type: unshielded symmetrical		Performance Criterion
Line to Ground	1 kV and 4kV 10/700(5/320) μ s (used with the primary protection)	C
Line to Ground	1 kV 10/700(5/320) μ s (used without the primary protection)	C
Note: Applicable only to ports which, according to the manufacturer's specification, the cable lengths greater than 3m.		
Analogue/digital data port, Port type: coaxial or shielded		Performance Criterion
Shield to ground	0.5 kV 1.2/50(8/20) μ s	B
Note: Applicable only to ports which, according to the manufacturer's specification, the cable lengths greater than 3m.		
DC network power port		Performance Criterion
Line to reference ground	0.5 kV 1.2/50(8/20) μ s	B
<p>Note: Applicable only to ports which, according to the manufacturer's specification,</p> <p>(1) The cable lengths greater than 3m;</p> <p>(2) May connect directly to outdoor cables.</p> <p>(3) Where the surge coupling network for the 10/700 (5/320) μs waveform affects the functioning of high speed data ports, the test shall be carried out using a 1,2/50 (8/20) μs waveform and appropriate coupling network.</p> <p>(4) The number of pulses applied shall be as follows:</p> <p>Five positive pulses line-to-neutral at 90° phase</p> <p>Five negative pulses line-to-neutral at 270° phase</p> <p>The following additional pulses are required only if the EUT has an earth connection or if the EUT is earthed via any AE.</p> <p>Five positive pulses line-to-earth at 90° phase</p> <p>Five negative pulses line-to-earth at 270° phase</p> <p>Five negative pulses neutral-to-earth at 90° phase</p> <p>Five positive pulses neutral-to-earth at 270° phase</p>		

11.6 Test Result

Sample No. Y25080103-01						
Injected Port	AC Mains Power		Wave Type	1.2/50us-8/20us		
Pulse Interval	60s		Pulse times:	5 times at each polarity		
Operation Mode	Coupling Line	Level	Required	Observation		Result
				Positive	Negative	
Mode 3 DP	L-N	±0.5kV	B	A ⁽¹⁾	A ⁽¹⁾	Pass
Mode 3 DP	L-N	±1kV	B	A ⁽¹⁾	A ⁽¹⁾	Pass
Mode 3 DP	L-PE	±0.5kV	B	A ⁽¹⁾	A ⁽¹⁾	Pass
Mode 3 DP	L-PE	±1kV	B	A ⁽¹⁾	A ⁽¹⁾	Pass
Mode 3 DP	L-PE	±2kV	B	A ⁽¹⁾	A ⁽¹⁾	Pass
Mode 3 DP	N-PE	±0.5kV	B	A ⁽¹⁾	A ⁽¹⁾	Pass
Mode 3 DP	N-PE	±1kV	B	A ⁽¹⁾	A ⁽¹⁾	Pass
Mode 3 DP	N-PE	±2kV	B	A ⁽¹⁾	A ⁽¹⁾	Pass
Remark						
(1)	Operation as intend, no loss of function during test and after test.					

12 Immunity to Conducted Disturbances, Induced by Radio-frequency Fields

12.1 General Information

Test date	Sep. 01, 2025	Test engineer	Ben Hu	
Climate condition	Ambient temperature	24.7°C	Relative humidity	50.1%
	Atmospheric pressure	100.9kPa		
Test place	Shield Room 3#			

12.2 Test Equipment

Equipment	Manufacturer	Model No.	Serial No.	Last Cal.	Cal. Interval
Audio Analyzer	Rohde & Schwarz	UPV	101525	Feb. 17, 2025	1 Year
Microwave Signal Generator	Rohde & Schwarz	SMB100A	103231	Feb. 17, 2025	1 Year
COUPLING / DECOUPLING NETWORK	TESEQ	CDN M016	28987	Feb. 17, 2025	1 Year
RF Power Amplifiers	AR	75A250A	0332892	Feb. 17, 2025	1 Year
Directional Coupler	AR	DC2600M2	0333399	Feb. 17, 2025	1 Year
Power Meter	Rohde & Schwarz	NRVS	101785	Feb. 17, 2025	1 Year
Coaxial voltage measurement probe	Rohde & Schwarz	URV5-Z4	100215	Feb. 17, 2025	1 Year
COUPLING / DECOUPLING NETWORK	TESEQ	CDN M016	30436	Feb. 17, 2025	1 Year
Bi-Directional RF Attenuators	Bird	75-A-FFN-06	0751	N/A	N/A
Test Software	Rohde & Schwarz	EMC32	Ver 10.28.00	N/A	N/A

12.3 Reference Standard

EN 55035:2017,
 EN 55035:2017/A11:2020,
 BS EN 55035:2017+A11:2020,
 CISPR 35:2016,
 IEC 61000-4-6:2023

12.4 Test Arrangement

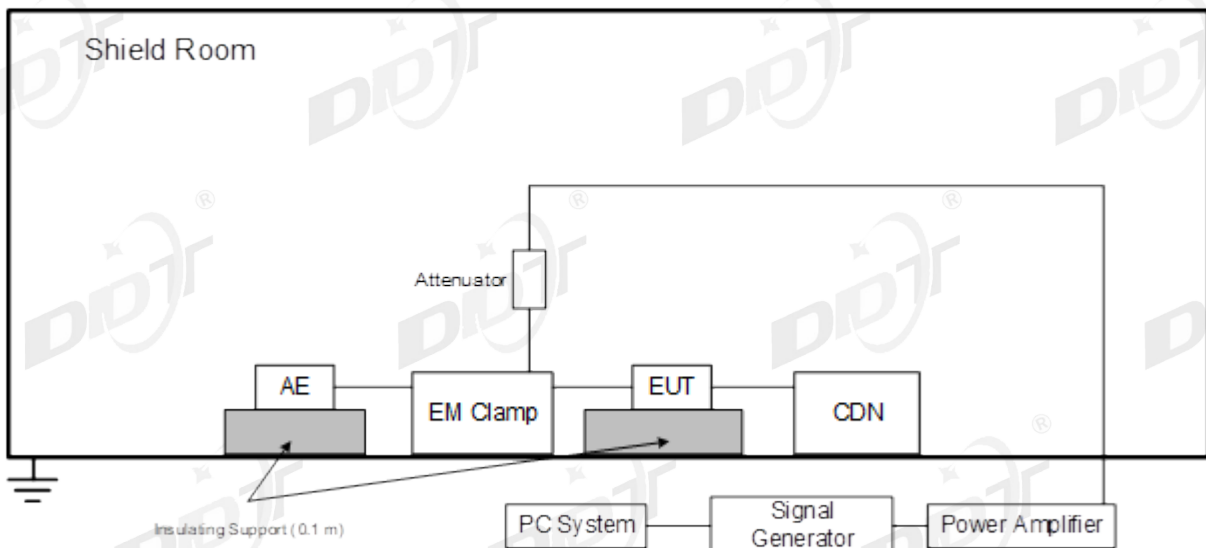
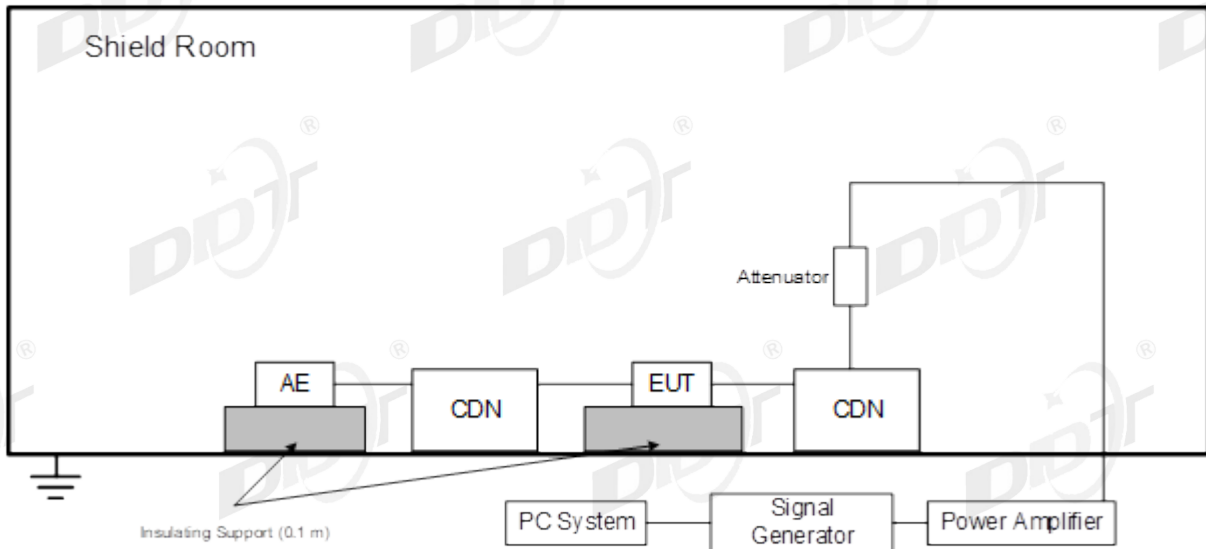

The EUT are placed on an insulating support 0.1m high above a ground reference plane. CDN (coupling and decoupling device) is placed on the ground plane at a distance 0.1 m to 0.3 m from EUT. Cables between CDN and EUT are as short as possible, and their height above the ground reference plane shall be at least 30 mm.

The disturbance signal described below is injected to EUT through CDN.

The EUT operates within its operational mode(s).

Recording the EUT operating situation during compliance testing and decide the EUT immunity criterion.

12.5 Test Specification and Limit

Test Level		Performance Criteria
Frequency and Field Strength	0.15MHz to 10MHz, 3V rms voltage level of the unmodulated signal	A
	10MHz to 30MHz, 3V to 1V rms voltage level of the unmodulated signal	
	30MHz to 80MHz, 1V rms voltage level of the unmodulated signal	
Modulation	AM modulated to a depth of 80% by a sine wave of 1kHz, (note 1)	
Step Size	1% increments	
Dwell time	<5 Sec.	

Note 1: The 1kHz modulation may be replaced by a different audio modulation frequency more appropriate for a given EUT if, for example, 1kHz is not within the operating audio range of the EUT.

For audio output function (if applied):

Performance criterion A

During the test the audio output function shall be maintained. The measured acoustic interference ratio and/or the measured electrical interference ratio during the test shall be -20 dB or better.

12.6 Test Result

Sample No. Y25080103-01						
Steps: 1%		Dwell time: 1s		Modulation: 1KHz 80% AM		
Operation mode	Frequency Range	Injected Position	Level	Required	Observation	Result
Mode 3 DP	0.15MHz ~ 10MHz	AC Mains Power	3V	A	A ⁽¹⁾	Pass
Mode 3 DP	10MHz ~ 30MHz	AC Mains Power	3V ~ 1V	A	A ⁽¹⁾	Pass
Mode 3 DP	30MHz ~ 80MHz	AC Mains Power	1V	A	A ⁽¹⁾	Pass
Remark						
(1) Operation as intend, no loss of function during test and after test.						

Audio output function result: <input type="checkbox"/> this device without audio output function.			
Method	Port	Acoustic interference ratio L1-L0 (dB) Required: ≤-20dB	Result
<input type="checkbox"/> acoustic measurement	N/A	N/A	N/A
<input checked="" type="checkbox"/> electrical measurement	Audio Out	-35.53	Pass

13 Power Frequency Magnetic Field Immunity

13.1 General Information

Test date	Sep. 01, 2025	Test engineer	Ben Hu	
Climate condition	Ambient temperature	24.7°C	Relative humidity	50.1%
	Atmospheric pressure	100.9kPa		
Test place	Shield Room 3#			

13.2 Test Equipment

Equipment	Manufacturer	Model No.	Serial No.	Last Cal.	Cal. Interval
Multifunctional Generator	EMTEST	UCS 500N7.1	P1303110687	Feb. 17, 2025	1 Year
Motor Variac	EMTEST	MV 2616	P1303109290	Feb. 17, 2025	1 Year
Magnetic Coil	EMTEST	MS 100N	0512-13	Feb. 17, 2025	1 Year
Power transformer	EMTEST	MC 2630	0912-65	Feb. 17, 2025	1 Year
Test Software	EM TEST	iec.control	Version 5.2.3	N/A	N/A

13.3 Reference Standard

EN 55035:2017,
 EN 55035:2017/A11:2020,
 BS EN 55035:2017+A11:2020,
 CISPR 35:2016,
 IEC 61000-4-8:2009

13.4 Test Arrangement

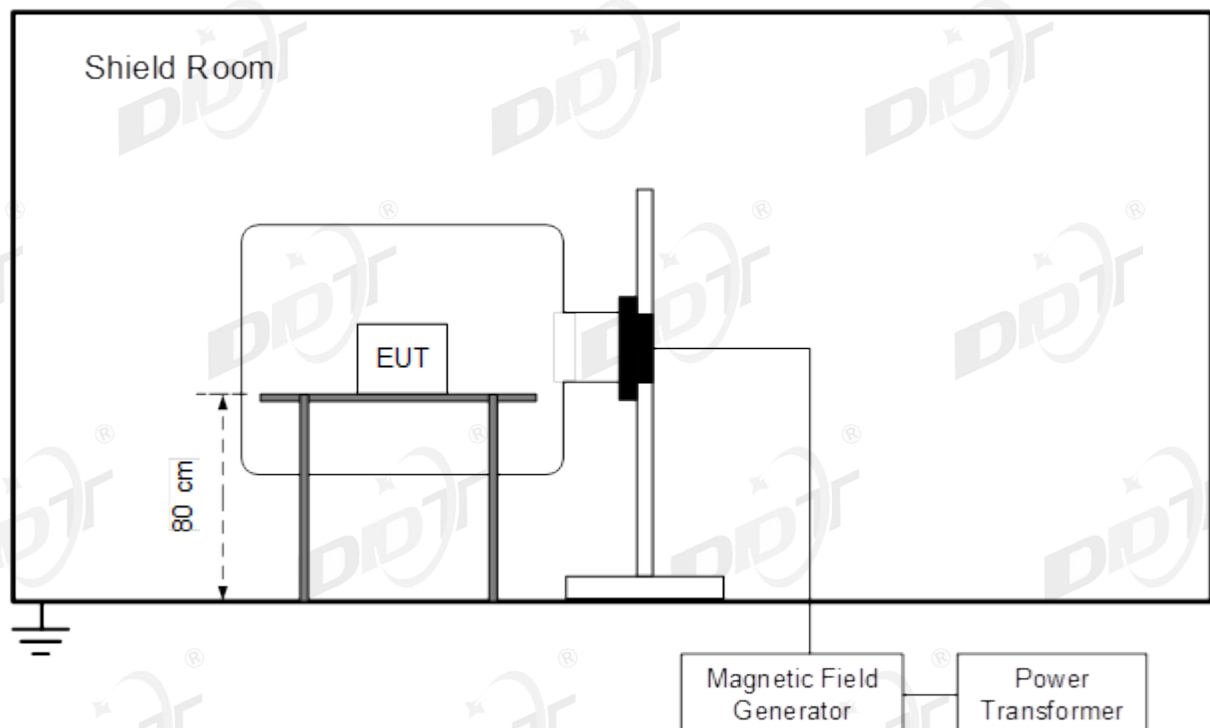

The EUT shall be subjected to the test magnetic field by using the induction coil of standard dimensions (1m*1m). Then induction coil shall then be rotated by 90° in order to expose the EUT to the test field with different orientations.

13.5 Test Specification and Limit

Magnetic Field Strength (A/m)	Performance Criterion
1	A

13.6 Test Result

Sample No. Y25080103-01						
Operation Mode	Test Level	Coil Orientation	Coil Duration	Required	Observation	Result
Mode 1 HDMI1	1A/m	X	5 min / coil	A	A ⁽¹⁾	Pass
Mode 1 HDMI1	1A/m	Y	5 min / coil	A	A ⁽¹⁾	Pass
Mode 1 HDMI1	1A/m	Z	5 min / coil	A	A ⁽¹⁾	Pass
Remark						
(1)	Operation as intend, no loss of function during test and after test.					

14 Voltage Dips, Short Interruptions and Voltage Variations Immunity

14.1 General Information

Test date	Sep. 01, 2025	Test engineer	Ben Hu	
Climate condition	Ambient temperature	24.7°C	Relative humidity	50.1%
	Atmospheric pressure	100.9kPa		
Test place	Shield Room 3#			

14.2 Test Equipment

Equipment	Manufacturer	Model No.	Serial No.	Last Cal.	Cal. Interval
Multifunctional Generator	EMTEST	UCS 500N7.1	P1303110687	Feb. 17, 2025	1 Year
Motor Variac	EMTEST	MV 2616	P1303109290	Feb. 17, 2025	1 Year
Test Software	EM TEST	iec.control	Version 5.2.3	N/A	N/A

14.3 Reference Standard

EN 55035:2017,
 EN 55035:2017/A11:2020,
 BS EN 55035:2017+A11:2020,
 CISPR 35:2016,
 IEC 61000-4-11:2020/COR2:2022

14.4 Test Arrangement

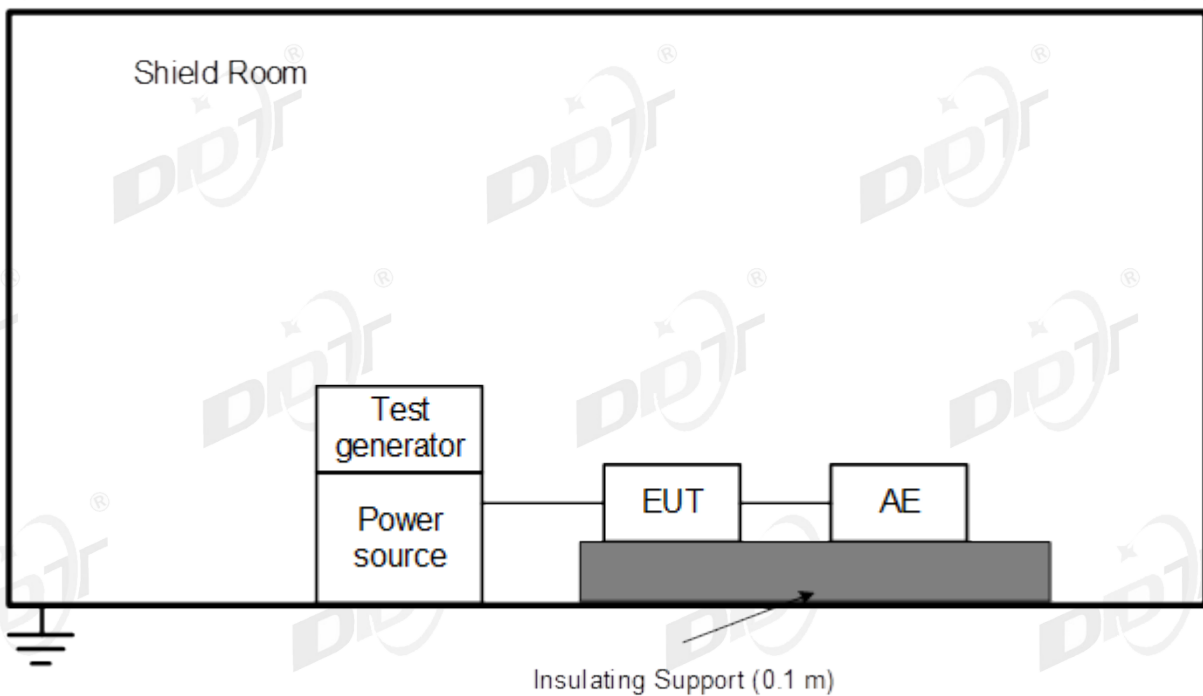

The EUT and test generator were setup as shown. The interruptions are introduced at selected phase angles with specified duration. Record any degradation of performance.

14.5 Test Specification and Limit

Test Level %UT	Duration (in period)	Performance Criterion
<5	0.5	B
70	25 for 50Hz/30 for 60Hz	C
<5	250 for 50Hz/300 for 60Hz	C

14.6 Test Result

Sample No. Y25080103-01							
Operation Mode	Operation Voltage	%Ur	Phase Angle	Duration (in period)	Required	Observation	Result
Mode 3 DP	100V 60Hz	0	0°,180°	0.5P	B	A ⁽¹⁾	Pass
Mode 3 DP	100V 60Hz	70	0°,180°	30P	C	A ⁽¹⁾	Pass
Mode 3 DP	100V 60Hz	0	0°,180°	300P	C	B ⁽²⁾	Pass
Mode 3 DP	240V 50Hz	0	0°,180°	0.5P	B	A ⁽¹⁾	Pass
Mode 3 DP	240V 50Hz	70	0°,180°	25P	C	A ⁽¹⁾	Pass
Mode 3 DP	240V 50Hz	0	0°,180°	250P	C	B ⁽²⁾	Pass
Remark							
(1)	Operation as intend, no loss of function during test and after test.						
(2)	Temporary loss of function or degradation of performance which ceases after the disturbance ceases, and from which the equipment under test recovers its normal performance, without operator intervention.						

Annex A. Test Setup Photos

A.1 Conducted Emissions (AC mains power ports)

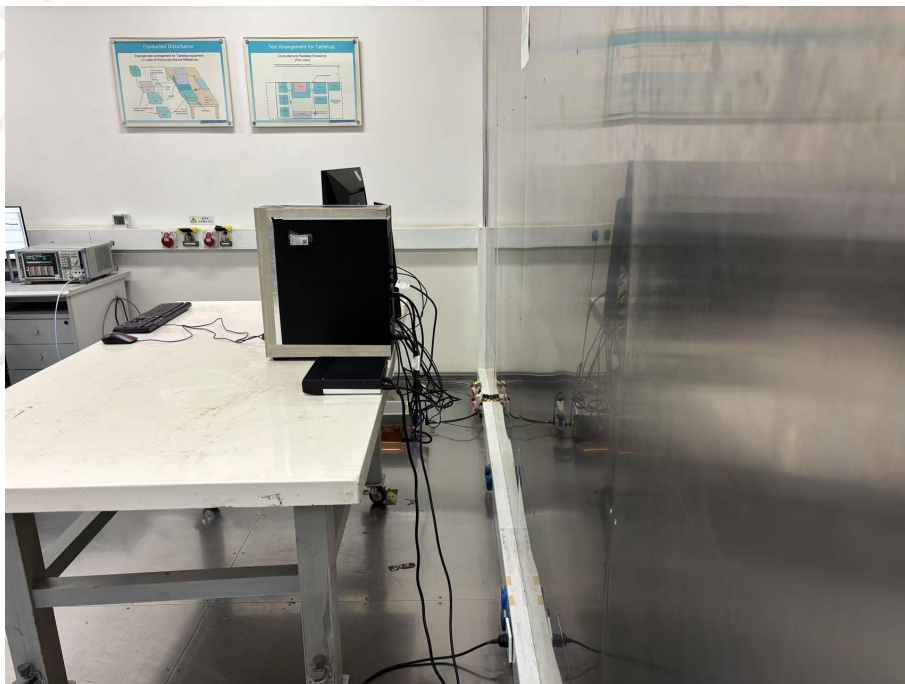

A.2 Radiated Emissions (30MHz to 1GHz)

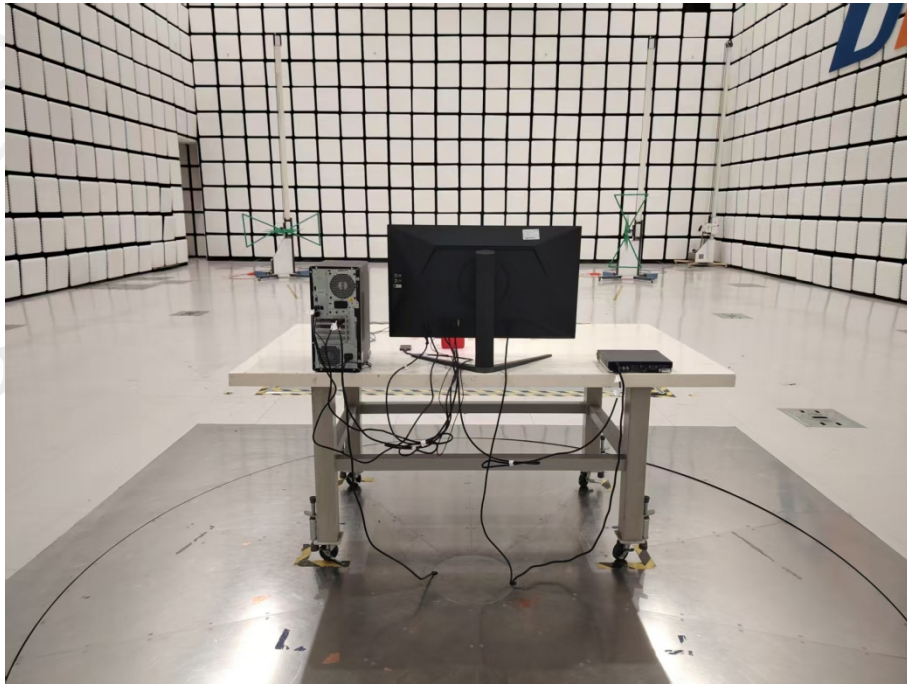

A.3 Radiated Emissions (Above 1GHz)

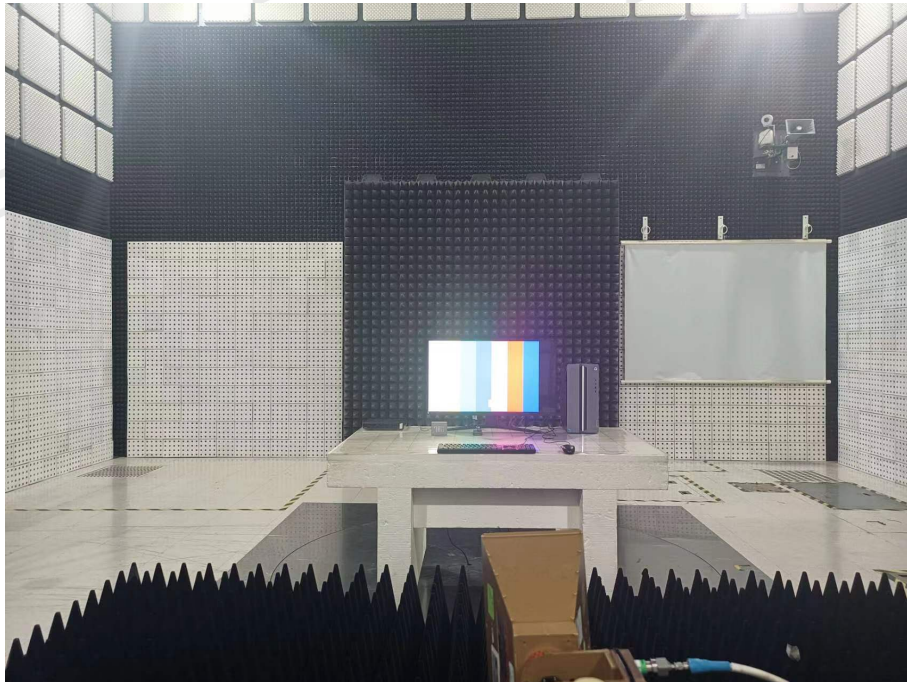

A.4 Harmonic Current Emissions



A.5 Voltage Changes, Voltage Fluctuations and Flicker



A.6 Electrostatic Discharge Immunity



A.7 Radiated, Radio-frequency, Electromagnetic Field Immunity

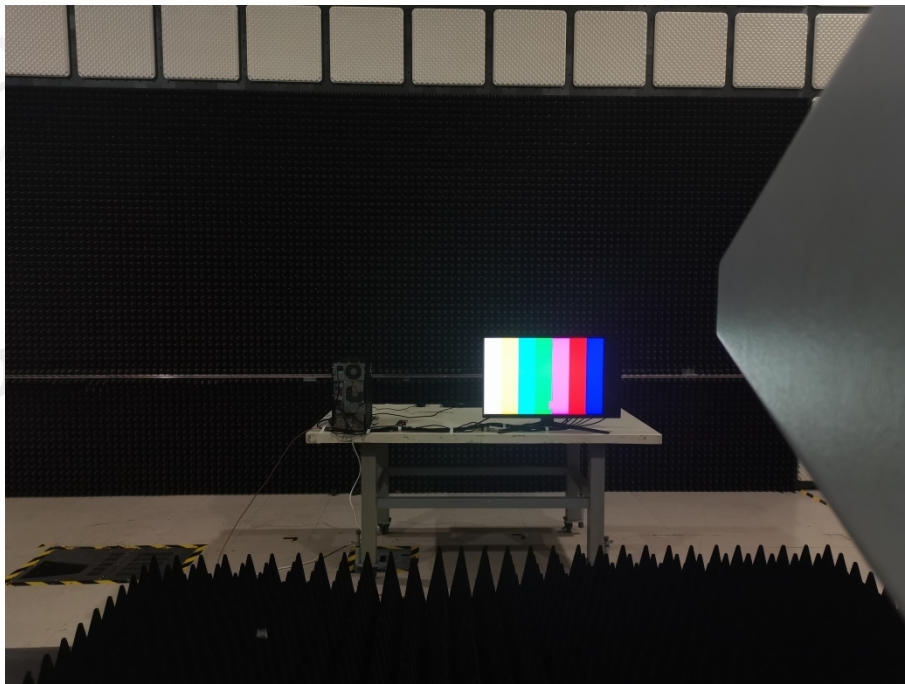
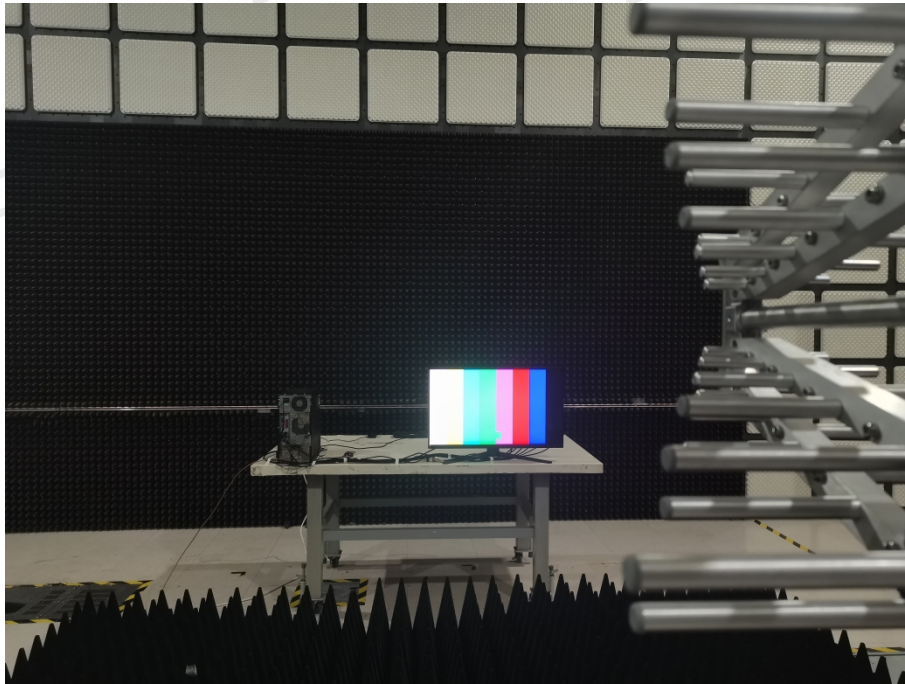

A.8 Electrical Fast Transient/Burst Immunity



A.9 Surge Immunity



A.10 Immunity to Conducted Disturbances, Induced by Radio-frequency Fields

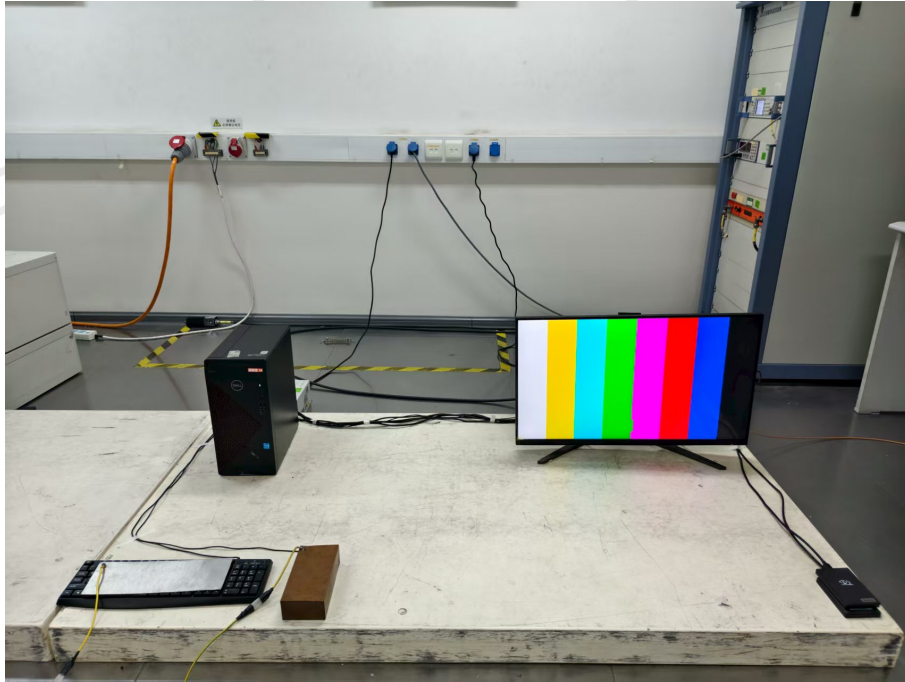

A.11 Power Frequency Magnetic Field Immunity



A.12 Voltage Dips, Short Interruptions and Voltage Variations Immunity



Statement

1. The report is invalid without the inspection and testing special seal of the company.
2. This report is invalid if altered.
3. This report is responsible for the conformance testing of sample(s) received.
4. This report shall not be reproduced, without the written approval of test laboratory. The copy of the report not stamped again with the inspection and testing special seal is invalid.
5. Item with “☆” was subcontracted to other laboratories.
6. The report without CMA mark indicated that either test item(s) not accredited by CMA or test item(s) accredited by CMA but the report is only used for development or quality control which purposes within the company that has no effect on social proof.
7. Any objections must be raised to our company within 15 days on receiving the report, overdue will not be accepted.
8. The sample(s) must be collected within three months, overdue will be dealt with by our company.
9. The report is invalid without the signature of editor, reviewer, approver.

Test Institution: Tianjin Dongdian Testing Service Co., Ltd.

Address: Building D-1, No. 19, Weisi Road, Microelectronics Industrial Park Development Area, Tianjin, China.

Postcode: 300385

Tel: 022-58038033

Fax: 022-58038033

Website: <http://www.ddttest.com>

END OF REPORT